



# SRM-225 GRASS TRIMMER / BRUSH CUTTER

## *Operator's Manual*

### ⚠ WARNING



#### **Burn Hazard**

*The muffler or catalytic muffler and surrounding cover may become extremely hot. Always keep clear of exhaust and muffler area, otherwise serious personal injury may occur.*

### ⚠ WARNING

*The engine exhaust from this product contains chemicals known to the State of California to cause cancer, birth defects or other reproductive harm.*

### ⚠ WARNING



*Users of this equipment risk injury to themselves and others if the unit is used improperly and/or safety precautions are not followed. ECHO provides an operator's manual and a safety manual. Both must be read and understood for proper and safe operation. Failure to do so could result in serious injury.*

Specifications, descriptions and illustrative material in this literature are as accurate as known at the time of publication, but are subject to change without notice. Illustrations may include optional equipment and accessories, and may not include all standard equipment.

TABLE OF CONTENTS

Table of Contents ..... 2

Introduction ..... 3

    The Operator’s Manual ..... 3

    The Safety Manual ..... 3

Servicing Information ..... 3

    Parts/Serial Number ..... 3

    Service ..... 3

    Echo Consumer Product Support ..... 3

    Warranty Registration ..... 3

    Additional or Replacement Manuals ..... 4

Safety ..... 4

    Manual Safety Symbols and Important Information ..... 4

    International Symbols ..... 5

    Personal Condition and Safety Equipment ..... 6

    Equipment ..... 8

Emission Control (Exhaust & Evaporative) ..... 9

    EPA 2010 and Later and/or C.A.R.B. TIER III ..... 9

Description ..... 10

Contents ..... 12

Assembly ..... 13

    Plastic Shield Installation ..... 13

    Nylon Line Head Installation ..... 13

    To Advance Trimmer Line ..... 14

    Remove Nylon Line Head ..... 14

    Support Handle Installation ..... 14

Operation ..... 15

    Operation With Blades ..... 15

    Blade Selection ..... 16

    Fuel ..... 17

    Starting Cold Engine ..... 18

    Starting Warm Engine ..... 19

    Stopping Engine ..... 20

Maintenance ..... 21

    Skill Levels ..... 21

    Maintenance Intervals ..... 21

    Air Filter ..... 22

    Fuel Filter ..... 22

    Spark Plug ..... 23

    Cooling System ..... 23

    Exhaust System ..... 24

    Carburetor Adjustment ..... 25

    Lubrication ..... 26

    Nylon Line Head Disassembly Instructions ..... 27

    Nylon Line Replacement ..... 27

    Sharpening Metal Blades ..... 28

Troubleshooting ..... 30

Storage ..... 31

    Long Term Storage (Over 30 Days) ..... 31

Specifications ..... 32

Warranty Statements ..... 33

Notes ..... 35

## INTRODUCTION

Welcome to the ECHO family. This ECHO product was designed and manufactured to provide long life and on-the-job dependability. Read and understand this manual and the SAFETY MANUAL. You will find both easy to use and full of helpful operating tips and SAFETY messages.

### The Operator's Manual

Keep it in a safe place for future reference. Contains specifications and information for safety, operation, maintenance, storage and assembly specific to this product.

### The Safety Manual

Keep it in a safe place for future reference. Explains possible hazards and the measures you should take to insure safe operation.

## SERVICING INFORMATION

### Parts/Serial Number

Genuine ECHO Parts and ECHO REPOWER™ Parts and Assemblies for your ECHO products are available only from an Authorized ECHO Dealer. When you do need to buy parts **always** have the Model Number and Serial Number of the unit with you. You can find these numbers on the engine housing. For future reference, write them in the space provided below.

Model No. \_\_\_\_\_ SN. \_\_\_\_\_



### Service

Service of this product during the warranty period must be performed by an Authorized ECHO Service Dealer. For the name and address of the Authorized ECHO Service Dealer nearest you, ask your retailer or call: 1-800-432-ECHO (3246). Dealer information is also available on our Web Site. When presenting your unit for Warranty service/repairs, proof of purchase is required.

### Echo Consumer Product Support

If you require assistance or have questions concerning the application, operation or maintenance of this product you may call the ECHO Consumer Product Support Department at 1-800-673-1558 from 8:30 am to 4:30 pm (Central Standard Time) Monday through Friday. Before calling, please know the model and serial number of your unit.

### Warranty Registration

To ensure trouble free warranty coverage it is important that you register your ECHO equipment on-line at [www.echo-usa.com](http://www.echo-usa.com) or by filling out the warranty registration card supplied with your unit. Registering your product confirms your warranty coverage and provides a direct link between you and ECHO if we find it necessary to contact you.

## Additional or Replacement Manuals

**Replacement Operator, Safety Manuals, and Parts Catalogs** are available from your ECHO dealer or at [www.echo-usa.com](http://www.echo-usa.com) or by contacting ECHO Inc., 400 Oakwood Road, Lake Zurich, IL 60047 (800-673-1558). Always check the ECHO Web Site for updated information.



For more information scan this QR code.

**Safety Videos** are available from your Echo dealer. A \$5.00 shipping charge will be required for each video.

## SAFETY

### Manual Safety Symbols and Important Information

Throughout this manual and on the product itself, you will find safety alerts and helpful, informational messages preceded by symbols or key words. The following is an explanation of those symbols and key words and what they mean to you.

#### DANGER

*The safety alert symbol accompanied by the word “DANGER” calls attention to an act or condition which WILL lead to serious personal injury or death if not avoided.*

#### WARNING

*The safety alert symbol accompanied by the word “WARNING” calls attention to an act or condition which CAN lead to serious personal injury or death if not avoided.*

#### CAUTION

*The safety alert symbol accompanied by the word “CAUTION” calls attention to an act or condition which may lead to minor or moderate personal injury if not avoided.*

#### NOTICE

*The enclosed message provides information necessary for the protection of the unit.*













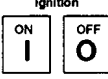





Note: This enclosed message provides tips for use, care and maintenance of the unit.



#### CIRCLE AND SLASH SYMBOL

This symbol means the specific action shown is prohibited. Ignoring these prohibitions can result in serious or fatal injury.

**International Symbols**

Symbol	Description	Symbol	Description	Symbol	Description	Symbol	Description
	Warning, See Operator's Manual	<b>H</b>	Carburetor Adjustment - High speed mixture		DO NOT allow flames or sparks near fuel		Ignition ON / OFF
	Wear eye, ear and head protection	<b>T</b>	Carburetor Adjustment - Idle speed		DO NOT smoke near fuel		Primer Bulb
	Wear hand and foot protection	<b>L</b>	Carburetor Adjustment - Low speed mixture		Choke Control "Run" Position (Choke Open)		Choke Control "Cold Start" Position (Choke Closed)
	Safety/Alert		Emergency Stop		Keep feet away from blade		Rotating Cutting Attachment
	Hot Surface		Fuel and oil mixture			Keep bystanders and helpers away 15 m (50 ft.).	
		AVOID KICKOUT. Keep bystanders at least 15 meters (50 feet) away.			Thrown objects		Direction of blade
		Beware Thrown Objects Wear Eye Protection					



**LOOK BEFORE YOU PUMP!**  
Ethanol Percentage  
0% - 10% 15% - 30% - 50% - 85%  
**USE E10 OR LESS FUEL**  
Do not use any fuel containing greater than 10 percent ethanol (E10) in this equipment. It may cause damage or failure and is prohibited by Federal Law.  
For Details, see the "Fuel" Section of your Operators Manual

## Personal Condition and Safety Equipment

### WARNING

*Users of this product risk injury to themselves and others if the unit is used improperly and/or safety precautions are not followed. Proper clothing and safety gear must be worn when operating unit.*

#### Physical Condition

Your judgment and physical dexterity may not be good:

- if you are tired or sick,
- if you are taking medication,
- if you have taken alcohol or drugs.

Operate unit only if you are physically and mentally well.

#### Eye Protection

Eye protection that meets ANSI Z87.1, CE, or CSA Z94.3 requirements must be worn whenever you operate the unit.

#### Hand Protection

Wear no-slip, heavy duty work gloves to improve your grip on the handles. Gloves also reduce the transmission of machine vibration to your hands.

#### Breathing Protection

Wear a facemask to protect against dust.

#### Hearing Protection

ECHO recommends wearing hearing protection whenever unit is used.

#### Proper Clothing

Wear snug fitting, durable clothing;

- Pants should have long legs, shirts with long sleeves.
- DO NOT WEAR SHORTS,
- DO NOT WEAR TIES, SCARVES, JEWELRY, or clothing with loose or hanging items that could become entangled in moving parts or surrounding growth.

Wear sturdy work shoes with nonskid soles;

- DO NOT WEAR OPEN TOED SHOES,
- DO NOT OPERATE UNIT BAREFOOTED.

Wear no-slip, heavy duty work gloves.

Keep long hair away from engine and air intake. Retain hair with cap or net.

#### Hot Humid Weather

Heavy protective clothing can increase operator fatigue which may lead to heat stroke. Schedule heavy work for early morning or late afternoon hours when temperatures are cooler.

## ⚠ WARNING

***The ignition components of this machine generate an electromagnetic field during operation which may interfere with some pacemakers. To reduce the risk of serious or fatal injury, persons with pacemakers should consult with their physician and the pacemaker manufacturer before operating this machine. In the absence of such information, ECHO does not recommend the use of ECHO products by anyone who has a pacemaker.***

### Vibration and Cold

It is believed that a condition called Raynaud's Phenomenon, which affects the fingers of certain individuals, may be brought about by exposure to vibration and cold. Exposure to vibration and cold may cause tingling and burning sensations, followed by loss of color and numbness in the fingers. The following precautions are strongly recommended, because the minimum exposure, which might trigger the ailment, is unknown.

- Keep your body warm, especially the head, neck, feet, ankles, hands, and wrists.
- Maintain good blood circulation by performing vigorous arm exercises during frequent work breaks, and also by not smoking.
- Limit the hours of operation. Try to fill each day with jobs where operating the unit or other hand-held power equipment is not required.
- If you experience discomfort, redness, and swelling of the fingers followed by whitening and loss of feeling, consult your physician before further exposing yourself to cold and vibration.

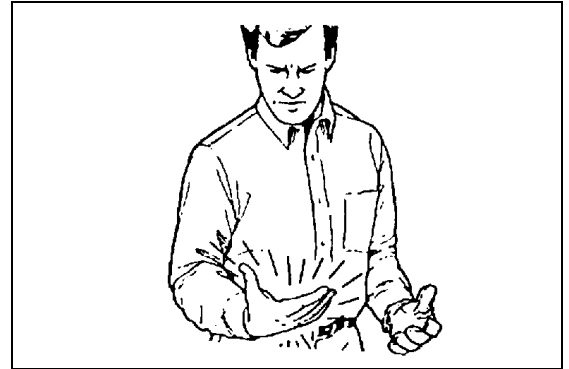

### Repetitive Stress Injuries

It is believed that overusing the muscles and tendons of the fingers, hands, arms, and shoulders may cause soreness, swelling, numbness, weakness, and extreme pain in those areas. Certain repetitive hand activities may put you at a high risk for developing a Repetitive Stress Injury (RSI). An extreme RSI condition is Carpal Tunnel Syndrome (CTS), which could occur when your wrist swells and squeezes a vital nerve that runs through the area. Some believe that prolonged exposure to vibration may contribute to CTS. CTS can cause severe pain for months or even years.

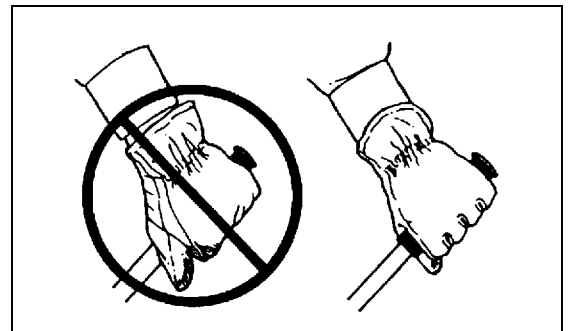

To reduce the risk of RSI/CTS, do the following:

- Avoid using your wrist in a bent, extended, or twisted position. Instead try to maintain a straight wrist position. Also, when grasping, use your whole hand, not just the thumb and index finger.
- Take periodic breaks to minimize repetition and rest your hands.
- Reduce the speed and force with which you do the repetitive movement.
- Do exercise to strengthen the hand and arm muscles.
- Immediately stop using all power equipment and consult a doctor if you feel tingling, numbness, or pain in the fingers, hands, wrists, or arms. The sooner RSI/CTS is diagnosed, the more likely permanent nerve and muscle damage can be prevented.

**⚠ DANGER**

**All over head electrical conductors and communications wires can have electricity flow with high voltages. This unit is not insulated against electrical current. Never touch wires directly or indirectly, otherwise serious injury or death may result.**

**⚠ DANGER**

**Do not operate this product indoors or in inadequately ventilated areas. Engine exhaust contains poisonous emissions and can cause serious injury or death.**

**Read the Manuals**

- Provide all users of this equipment with the Operator's Manual and Safety Manual for instructions on Safe Operation.

**Clear the Work Area**

- Spectators and fellow workers must be warned, and children and animals prevented from coming nearer than 15 m (50 ft.) while the unit is in use.

**Keep a Firm Grip**

- Always hold throttle handle and support handle with thumbs and fingers tightly encircling the handles.

**Keep a Solid Stance**

- Maintain footing and balance at all times. Do not stand on slippery, uneven or unstable surfaces. Do not work in odd positions or on ladders. Do not over reach.

**Avoid Hot Surfaces**

- Keep exhaust area clear of flammable debris. Avoid contact during and immediately after operation.



For more information scan this QR code.

**Equipment****⚠ WARNING**

**Use only ECHO approved attachments. Serious injury may result from the use of a non-approved attachment combination. ECHO, INC. will not be responsible for the failure of cutting devices, attachments or accessories which have not been tested and approved by ECHO. Read and comply with all safety instructions listed in this manual and safety manual.**

- Check unit for loose/missing nuts, bolts, and screws. Tighten and/or replace as needed.
- Inspect shield for damage and ensure that the cut-off knife is securely in place. Replace if either is damaged or missing.
- Check that the cutting attachment is firmly attached and in safe operating condition.



- Check that handle and harness (if included) are adjusted for safe, comfortable operation. See Assembly Section for proper adjustment.

### ⚠ WARNING

**Moving parts can amputate fingers or cause severe injuries. Keep hands, clothing and loose objects away from all openings.**

- **ALWAYS stop engine, disconnect spark plug, and make sure all moving parts have come to a complete stop before removing obstructions, clearing debris, or servicing unit.**
- **DO NOT start or operate unit unless all guards and protective covers are properly assembled to unit.**
- **NEVER reach into any opening while the engine is running. Moving parts may not be visible through openings.**

### ⚠ WARNING

**Check fuel system for leaks due to fuel tank damage, especially if the unit is dropped. If damage or leaks are found, do not use unit, otherwise serious personal injury or property damage may occur. Have unit repaired by an authorized servicing dealer before using.**

## EMISSION CONTROL (EXHAUST & EVAPORATIVE)

### EPA 2010 and Later and/or C.A.R.B. TIER III

The emission control system for the engine is EM (engine modification) and, if the second to last character of the Engine Family on the Emission Control Information label (sample below) is “C”, “K”, or “T”, the emission control system is EM and TWC (3-way catalyst). The fuel tank/fuel line emission control system is EVAP (evaporative emissions). Evaporative emissions for California models are only applicable to fuel tanks.

**An Emission Control Label** is located on the engine. (This is an EXAMPLE ONLY, information on label varies by engine FAMILY).

### Product Emission Durability (Emission Compliance Period)

The 50 or 300 hour emission compliance period is the time span selected by the manufacturer certifying the engine emissions output meets applicable emissions regulations, provided that approved maintenance procedures are followed as listed in the Maintenance Section of this manual.



DESCRIPTION

Locate the safety decal(s) on your unit. Make sure the decal(s) is legible and that you understand and follow the instructions on it. If a decal cannot be read, a new one can be ordered from your ECHO dealer. See PARTS ORDERING instructions for specific information.

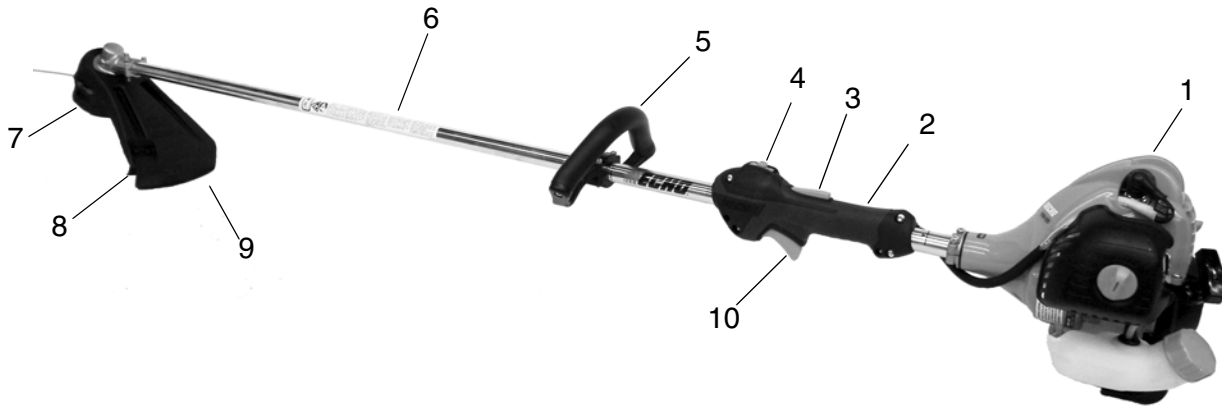
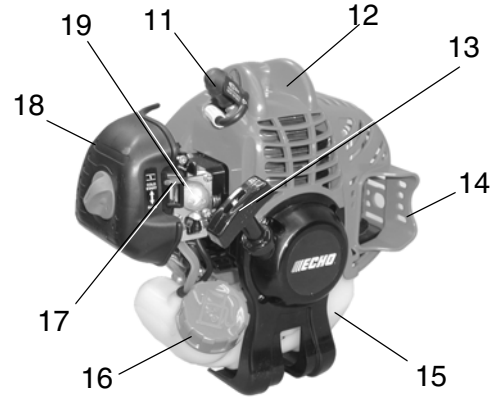



Shaft Label

	<p><b>PELIGRO</b> Este unidad puede ser peligrosa y producir lesiones personales graves o de la vida en forma ocasional. Para reducir el riesgo de lesiones, los operadores de la herramienta, los operadores de la herramienta y los espectadores deben leer y comprender el Manual del Operador y los Manuales de Seguridad que se entregan con esta herramienta.</p>	<p><b>EN</b> <b>! DANGER</b> This unit can be dangerous and cause serious injury if operators, bystanders, or spectators are not properly instructed. To reduce injury to operators, bystanders and spectators, the operator, bystanders and spectators must read and understand the Operator and Safety Manuals that come with this unit.</p>	<p><b>! DANGER</b> Blade/shaft attachment does not stop immediately after releasing throttle. Keep hands and feet clear of blade/shaft attachment unless engine is shut off and cutting attachment is not moving. Do not remove shaft, modify the shaft or install attachments or parts not approved by ECHO. Approved attachment information and replacement Operator and Safety Manuals are available from your ECHO dealer or <a href="http://www.echo-usa.com">www.echo-usa.com</a> for US countries. ECHO Inc. 400 Oldwood Road, Lake Zurich, IL 60047 (800-473-1506).</p>
--	---	--	---



Hot Label



1. **POWER HEAD** - Includes the Engine, Clutch, Fuel System, Ignition System and Recoil Starter.
2. **THROTTLE HANDLE - FOR RIGHT HAND** - Contains Stop Switch, Throttle Lockout, and Throttle Trigger.
3. **THROTTLE TRIGGER LOCKOUT** - This lever must be held during starting. Operation of the throttle trigger is prevented unless throttle trigger lockout lever is engaged.
4. **STOP SWITCH** - "SLIDE SWITCH" mounted on top of the Throttle Handle. Move switch FORWARD to RUN, BACK to STOP.
5. **SUPPORT HANDLE - FOR LEFT HAND** - The support handle is factory assembled to the Drive Shaft assembly but must be re-positioned for proper cutting attitude and operator comfort.
6. **DRIVE SHAFT ASSEMBLY** - Includes the Throttle Handle, Gear Housing assembly, Support Handle, Drive Shaft and Safety Decal.
7. **NYLON CUTTER HEAD** - Contains replaceable nylon trimming line that advances when the trimmer head is tapped against the ground while the head is turning at normal operating speed.
8. **CUT-OFF KNIFE** - Automatically trims line to the correct length: 5" after head is tapped on the ground. If trimmer is operated without a cut-off knife, the line will become too long, the engine will overheat, and engine damage may occur.
9. **PLASTIC DEBRIS SHIELD ASSEMBLY** - Included in plastic bag (co-pack). MUST be installed on unit before use, see Assembly Instructions. Shield assembly includes the Cut-Off Knife. Mounts on the Gear Housing Assembly just above the cutting attachment. Helps protect the operator by deflecting debris produced during the trimming operation. This shield must be replaced with the steel shield for blade use.
10. **THROTTLE TRIGGER** - Spring loaded to return to idle when released. During acceleration, press trigger gradually for best operating technique.
11. **SPARK PLUG** - Provides spark to ignite fuel mixture.
12. **ARM REST** - Provides arm rest during operation and protects arm from the hot engine.
13. **RECOIL STARTER HANDLE** - Pull handle slowly until starter engages, then quickly and firmly. When engine starts, return handle slowly. DO NOT let handle snap back or damage to unit will occur.
14. **SPARK ARRESTOR MUFFLER OR SPARK ARRESTOR MUFFLER WITH CATALYST** -The muffler or catalytic muffler controls exhaust noise and emission. The spark arrestor screen prevents hot, glowing particles of carbon from leaving the muffler. Keep exhaust area clear of flammable debris.
15. **FUEL TANK** - Contains fuel and fuel filter.
16. **FUEL TANK CAP** - Covers and seals fuel tank opening.
17. **CHOKE** - The choke control is located at the rear of the air cleaner housing. Move choke lever to Cold Start (  ) to close choke for cold start. Move choke lever to "Run" (  ) position to open choke.
18. **AIR CLEANER** - Contains replaceable filter element.
19. **PURGE BULB** - Pumping purge bulb before starting engine draws fresh fuel from the fuel tank, purging air from the carburetor. Pump purge bulb until fuel is visible and flows freely in the clear fuel tank return line. Pump purge bulb an additional 4 or 5 times.

CONTENTS

The ECHO product you purchased has been factory pre-assembled for your convenience. Due to packaging restrictions, shield installation and other assembly may be necessary.

After opening the carton, check for damage. Immediately notify your retailer or ECHO Dealer of damaged or missing parts. Use the contents list to check for missing parts.

\*Some Echo units may be factory pre-assembled. The nylon line head, plastic debris shield, and mounting hardware shown in the contents list are pre-assembled to the unit. Assembly tools are not supplied with these units. The front handle may need to be re-positioned for comfortable operation.

- \_\_\_\_ - 1 - Power Head / Drive Shaft Assembly
- \_\_\_\_ - 1, Operator's Manual
- \_\_\_\_ - 1, Safety Manual
- \_\_\_\_ - 1, Emission Control Warranty Statement
- \_\_\_\_ - 1, Warranty Registration Card
- \_\_\_\_ - 1, Safety Glasses
- \_\_\_\_ - 1, Echo Power Blend X™ 2-Stroke Oil Sample
- \* \_\_\_\_ - 1, Nylon Trimmer Head
- \* \_\_\_\_ - Assembly Tool(s)
- \* \_\_\_\_ - 1, Plastic Shield
- \* \_\_\_\_ - 1, Shield Plate
- \* \_\_\_\_ - 3, 5mm x 16mm Screws (shield mount)

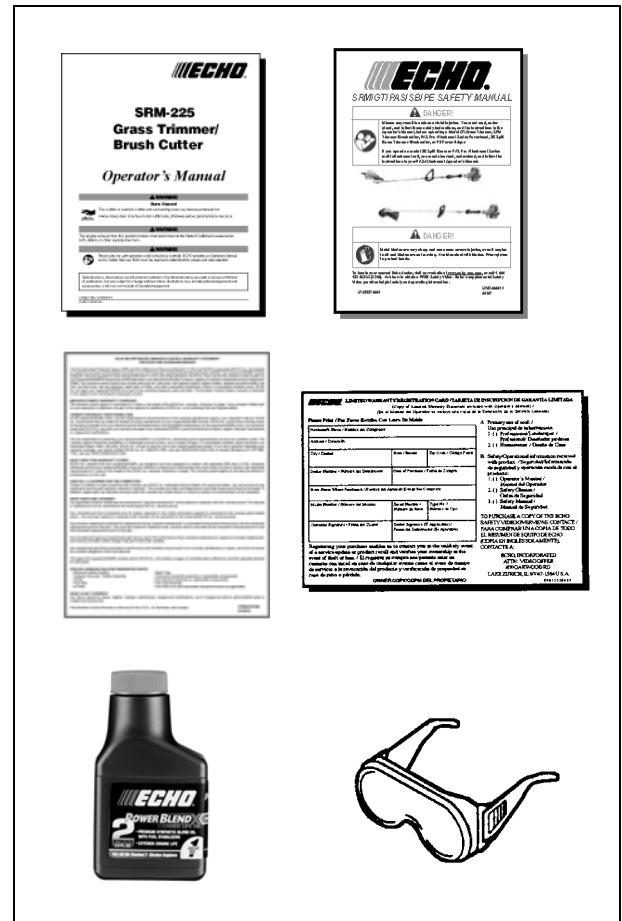

## ASSEMBLY

### Plastic Shield Installation

(Nylon line operation)

Parts Required: Plastic Debris Shield, Shield Plate,  
three (3) 5 x 16 mm screws.

#### ⚠ WARNING

**The plastic shield is for use with the Nylon Line Head only. Install Metal Shield when using plastic or metal blades, or serious injury may result.**

1. Remove plastic threaded shaft sleeve and adapter plate (C) from PTO shaft (A).
2. Place the shield on the bottom of the bearing housing flange.
3. Place shield plate (B) on shield, align holes. Install three (3) screws from bottom through plate and shield into gear case.
4. Assemble adapter plate (C) onto PTO shaft.

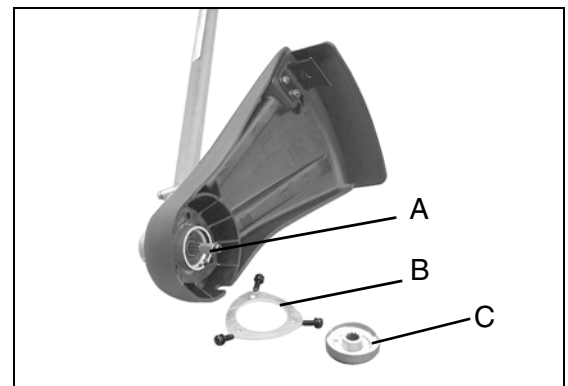

### Nylon Line Head Installation

Parts Required: Nylon Line Head.

#### ⚠ CAUTION

**Wear Gloves or personal injury may result:**

- **Cutoff knife is sharp.**
- **Gearcase and surrounding area may be hot.**

1. Be sure adapter plate (C) remains on PTO shaft (A).
2. Align locking hole in upper plate with notch in edge of gear housing and insert head locking tool (D).
3. Thread line head (E) onto shaft by turning it counter-clockwise until head is tight against adapter plate (C).
4. Remove locking tool (D).

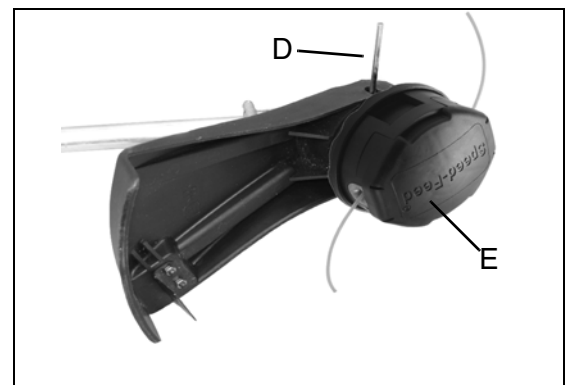
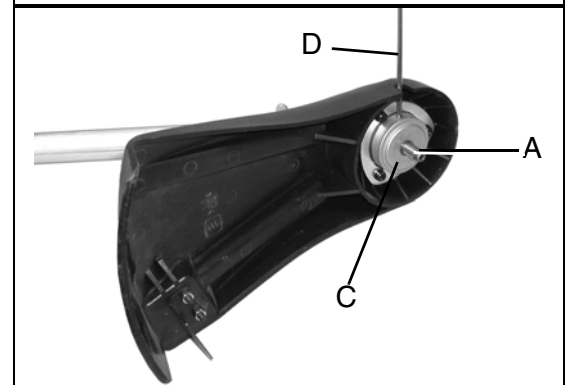

#### NOTICE

*Semi-automatic nylon line heads must be used only with plastic debris shield with cut-off knife. Using nylon line heads with metal debris shield can result in trimmer damage, caused by operation with excessive line length.*

Note: Your nylon line head may appear different than nylon line head shown.

## To Advance Trimmer Line

See Maintenance Section for nylon line replacement.

Note: To advance trimmer line, tap trimmer head against the ground while the head is turning at normal operating speed.

## Remove Nylon Line Head

Note: Do not disassemble nylon line head.

1. Align locking hole in upper plate with notch in edge of gear housing and insert head locking tool (D).
2. Remove line head (E) by turning it clockwise until head is completely off of shaft.
3. Remove locking tool (D).

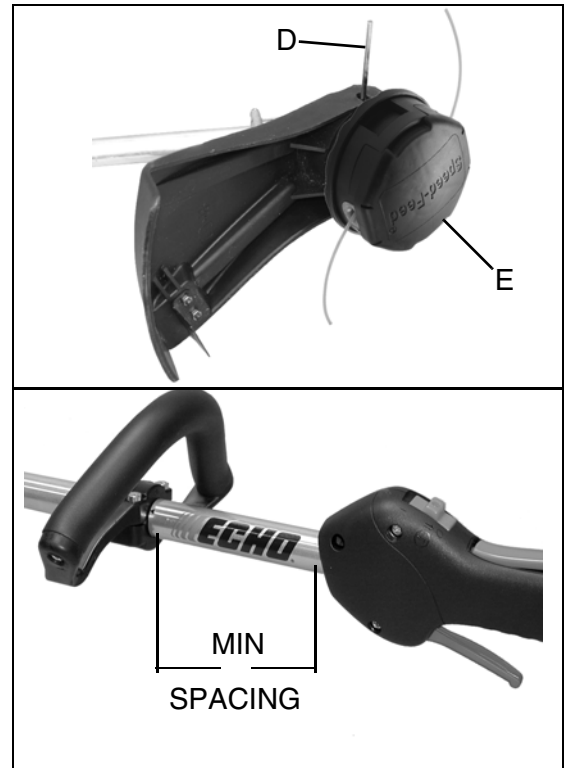

## Support Handle Installation

Note: Label shows minimum spacing for support handle location

1. Position support handle for comfortable operation and secure screws.

**OPERATION**

**⚠ WARNING**

*Moving parts can amputate fingers or cause severe injuries. Keep hands, clothing and loose objects away from all openings. Always stop engine, disconnect spark plug, and make sure all moving parts have come to a complete stop before removing obstructions, clearing debris, or servicing unit.*

**⚠ WARNING**

*Engine exhaust IS HOT, and contains Carbon Monoxide (CO), a poison gas. Breathing CO can cause unconsciousness, serious injury, or death. Exhaust can cause serious burns. ALWAYS position unit so that exhaust is directed away from your face and body.*

**⚠ WARNING**

*Operation of this equipment may create sparks that can start fires. This unit is equipped with a spark arrestor to prevent discharge of hot particles from the engine. Metal cutters can also create sparks if the cutter strikes rocks, metal, or other hard objects. Contact local fire authorities for laws or regulations regarding fire prevention requirements.*

**Operation With Blades**

**⚠ WARNING**

*Blade use DEMANDS specific Brush Cutter configuration. Operation without specified shield, barrier bar or U-handle, and harness can result in serious personal injury. Follow installation instructions.*

<b>TO USE THESE BLADES</b> 	<b>Pro Maxi-Cut Grass/Weed Blade</b>	<b>Rigid Plastic Tri-Cut Grass/Weed Blade</b>	<b>Metal Blade</b>
  You must install these parts!  	Support Handle, w/or w/o Barrier Bar	U-Handle or Support Handle w/Barrier Bar	U-Handle or Support Handle w/Barrier Bar
	Plastic Shield	Plastic Shield	Metal Shield
	Harness	Harness	Harness
	Upper Plate & Flat Washer	Upper Plate & Glide Cup	Upper/Lower Blade Plates
	Hex Nut	Hex Nut	Hex Nut
	New Cotter Pin	New Cotter Pin	New Cotter Pin

**⚠ WARNING**

**DO NOT INSTALL BLADES ON GT (CURVED SHAFT) MODEL TRIMMERS.**

- Arbor Diameter of Upper Blade Plate must match arbor diameter of blades.
- New cotter pin required each time blade is installed.
- Brush cutters over 16.5 lbs (7.5 kg) dry weight (weight w/o fuel) require a double shoulder harness.

Note: The Barrier Bar is used to restrict rearward movement of the unit. The Barrier Bar is NOT A HANDLE and should not be gripped when using or carrying the unit.

## Blade Selection

### WARNING

*The type of Blade used MUST be matched to the type and size of material cut. An improper or dull blade can cause serious personal injury. Blades MUST be sharp. Dull blades increase the chance of kick-out and injury to yourself and bystanders.*

**Plastic/Nylon Grass/Weed Blades** may be used where ever the nylon line head is used. DO NOT use this blade for heavy weeds or brush!

**8 Tooth Weed/Grass Blade** is designed for grass, garden debris and thick weeds up to 19 mm (3/4") diameter. DO NOT use this blade for brush or heavy woody growth.

**80 Tooth Brush Blade** is designed for cutting brush and woody growth up to 13 mm (1/2 in.) diameter.

**22 Tooth Clearing Blade** is designed for dense thickets and saplings up to 64 mm (2-1/2 in.) diameter.

**Use Shoulder/Waist Harness** Use of the Shoulder/Waist Harness is recommended for **ALL** Trimmer/Brush Cutter use, not just Blade operation. The Shoulder/Waist Harness when used in a trimming operation with nylon line head suspends the trimmer from the operator's shoulder and reduces operator fatigue.

During blade operation, the same fatigue reduction is achieved. Safety to the operator is also enhanced by reducing the possibility of blade contact with the operator's hands and feet by restricting trimmer movement.

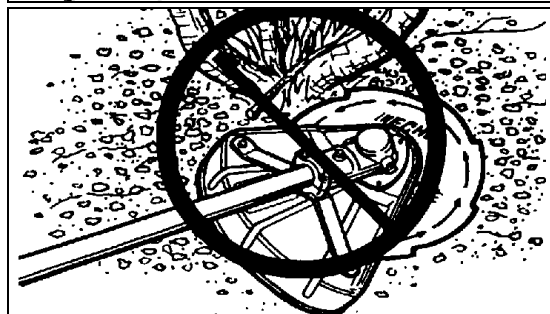





For more information  
scan this QR code.

## Fuel

### WARNING

**Alternative fuels, such as E-15 (15% ethanol), E-85 (85% ethanol) or any fuels not meeting ECHO requirements are NOT approved for use in ECHO 2-stroke gasoline engines. Use of alternative fuels may cause performance problems, loss of power, overheating, fuel vapor lock, and unintended machine operation, including, but not limited to, improper clutch engagement. Alternative fuels may also cause premature deterioration of fuel lines, gaskets, carburetors and other engine components.**

### Fuel Requirements

**Gasoline** - Use 89 Octane [R+M/2] (mid grade or higher) gasoline known to be good quality. Gasoline may contain up to 10% Ethanol (grain alcohol) or 15% MTBE (methyl tertiary-butyl ether). Gasoline containing methanol (wood alcohol) is **NOT** approved. ECHO brand Power Fuel™ is 93 octane, ethanol-free fuel premixed with ECHO Red Armor® engine oil at 50:1 ratio. Use of ECHO Power Fuel™ is recommended to extend engine life in all air-cooled 2-stroke and 2/4-stroke hybrid engines.

**Two Stroke Oil** - A two-stroke engine oil meeting ISO-L-EGD (ISO/CD 13738) and J.A.S.O. FD Standards must be used. Echo brand premium Power Blend X™ Universal 2-Stroke Oil meets these standards. Engine problems due to inadequate lubrication caused by failure to use an ISO-L-EGD (ISO/CD 13738) and J.A.S.O. FD certified oil, such as Echo premium Power Blend X™, will void the two-stroke engine warranty.

### NOTICE

*Echo premium Power Blend X™ Universal 2-Stroke Oil may be mixed at 50:1 ratio for application in all Echo engines sold in the past regardless of ratio specified in those manuals.*

## Handling Fuel

### DANGER

**Fuel is VERY flammable. Use extreme care when mixing, storing or handling, or serious personal injury may result.**

- **Use an approved fuel container.**
- **DO NOT smoke near fuel.**
- **DO NOT allow flames or sparks near fuel.**
- **Fuel tanks/cans may be under pressure. Always loosen fuel caps slowly allowing pressure to equalize.**
- **NEVER refuel a unit when the engine is HOT or RUNNING!**
- **DO NOT fill fuel tanks indoors. ALWAYS fill fuel tanks outdoors over bare ground.**
- **DO NOT overfill fuel tank. Wipe up spills immediately.**
- **Securely tighten fuel tank cap and close fuel container after refueling.**

- **Inspect for fuel leakage. If fuel leakage is found, do not start or operate unit until leakage is repaired.**
- **Move at least 3m (10 ft.) from refueling location before starting the engine.**

### Mixing Instructions

1. Fill an approved fuel container with half of the required amount of gasoline.
2. Add the proper amount of 2-stroke oil to gasoline.
3. Close container and shake to mix oil with gasoline.
4. Add remaining gasoline, close fuel container, and remix.

Fuel to Oil Mix - 50:1 Ratio			
U.S.		METRIC	
GAS	OIL	GAS	OIL
Gallons	Fl. oz.	Liter	cc.
1	2.6	4	80
2	5.2	8	160
5	13	20	400

### NOTICE

*Spilled fuel is a leading cause of hydrocarbon emissions. Some states may require the use of automatic fuel shut-off containers to reduce fuel spillage.*

### After use

- DO NOT store a unit with fuel in its tank. Leaks can occur. Return unused fuel to an approved fuel storage container.

**Storage** - Fuel storage laws vary by locality. Contact your local government for the laws affecting your area. As a precaution, store fuel in an approved, airtight container. Store in a well-ventilated, unoccupied building, away from sparks and flames.



For more information scan this QR code.

### NOTICE

*Stored fuel ages. Do not mix more fuel than you expect to use in thirty (30) days, ninety (90) days when a fuel stabilizer is added.*

### NOTICE

*Stored two-stroke fuel may separate. ALWAYS shake fuel container thoroughly before each use.*

## Starting Cold Engine

### ⚠ WARNING

**The attachment will operate immediately when the engine starts, and could result in possible serious injury. Keep movable parts of the attachment away from objects that could become entangled or thrown, and surfaces that could cause loss of control.**

1. **Stop Switch**  
Move stop switch button (A) forward, away from the STOP position.
2. **Choke**

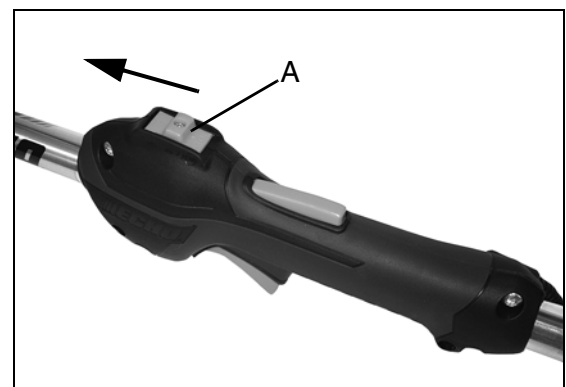

Move choke lever (B) to Cold Start Position (|←|).

### 3. Purge Bulb

Pump purge bulb (C) until fuel is visible and flows freely in the clear fuel tank return line. Pump bulb an additional 4 or 5 times.

### 4. Recoil Starter

Lay the unit on a flat area and keep movable attachment parts clear of all obstacles. Firmly grasp throttle handle and throttle trigger lockout with left hand and fully depress throttle trigger to wide open position. Rapidly pull recoil starter handle/rope (D) until engine fires (or maximum five [5] pulls).

### 5. Choke

After engine fires (or 5 pulls), move choke (B) to the Run (|↑|) (open) position. Firmly grasp throttle handle and throttle trigger lockout with left hand and fully depress throttle trigger to wide open position. Pull starter handle/rope until engine starts and runs. Release throttle trigger and allow unit to warm up at idle for several minutes.

Note: If engine does not start with choke in “Run” position after 5 pulls, repeat instructions 2 - 5.

### 6. Throttle Trigger

After engine warm-up, grip throttle handle and support handle. Depress the throttle trigger lockout, and gradually depress throttle trigger to increase engine RPM to operating speed.

## Starting Warm Engine

The starting procedure is the same as Cold Start except DO NOT close the choke, and do not hold throttle trigger fully depressed.

### **⚠ WARNING**

***The attachment should not move at idle, otherwise serious personal injury may result.***

Note: If attachment moves, readjust carburetor according to “Carburetor Adjustment” instructions in this manual or see your ECHO Dealer.

### 1. Stop Switch

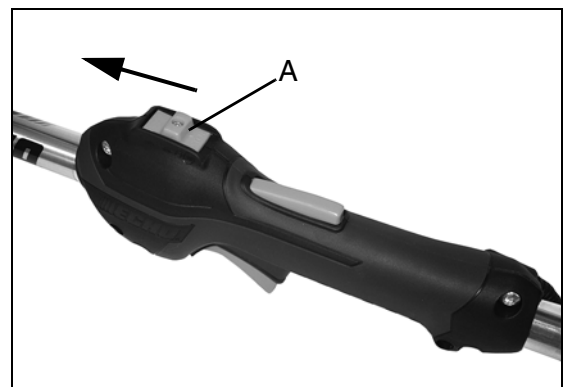
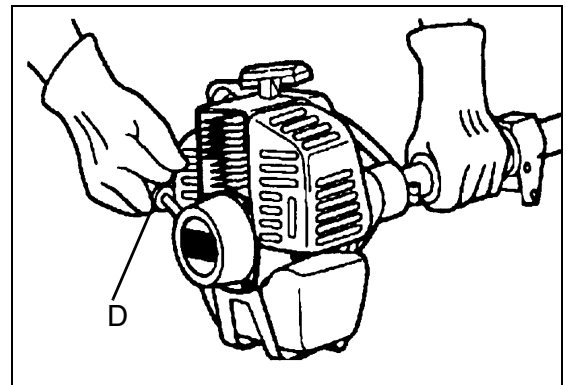
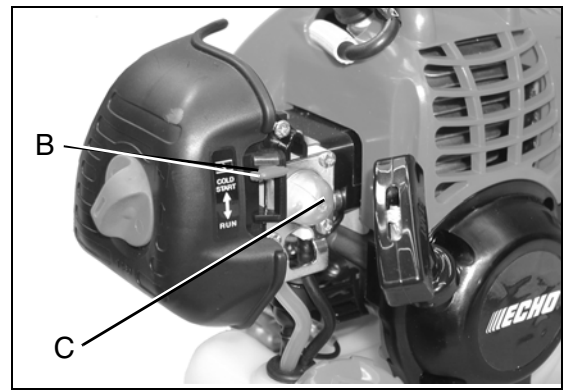

Move stop switch button (A) forward away from the STOP position.

### 2. Purge Bulb

Pump purge bulb (C) until fuel is visible in the "Clear" fuel return line. Pump bulb an additional 4 or 5 times.

### 3. Recoil Starter

Lay the unit on a flat area and keep movable attachment parts clear of all obstacles. Firmly grip throttle handle and throttle trigger lockout with left hand. Rapidly pull recoil starter handle/rope (D) until engine fires.

Note: If engine does not start after 5 pulls, use Cold Start Procedure.

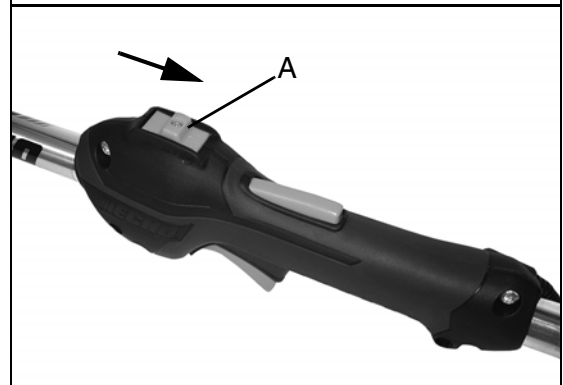
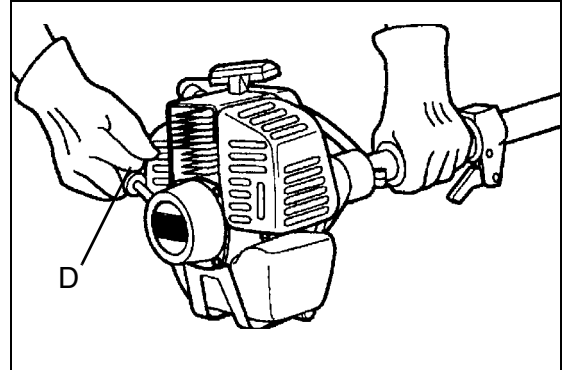
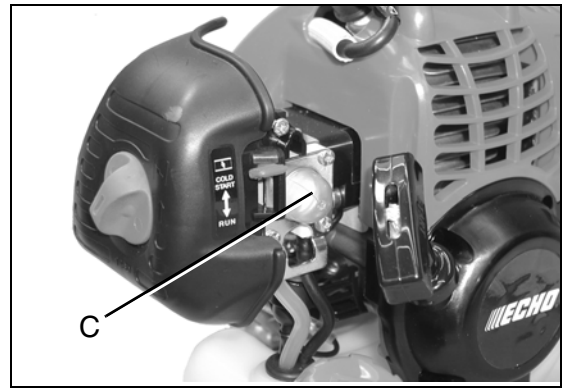

## Stopping Engine

### 1. Throttle

Release throttle trigger and allow engine to return to idle before shutting off engine.

### 2. Stop Switch

Move stop switch button (A) backward to STOP position.

## WARNING

**If engine does not stop when stop switch is moved to STOP position, close choke - COLD START position - to stall engine. Have your ECHO dealer repair stop switch before using unit again.**

## MAINTENANCE

### WARNING

***Moving parts can amputate fingers or cause severe injuries. Keep hands, clothing and loose objects away from all openings. Always stop engine, disconnect spark plug, and make sure all moving parts have come to a complete stop before removing obstructions, clearing debris, or servicing unit. Allow unit to cool before performing service. Wear gloves to protect hands from sharp edges and hot surfaces.***

Your ECHO unit is designed to provide many hours of trouble free service. Regular scheduled maintenance will help your unit achieve that goal. If you are unsure or are not equipped with the necessary tools, you may want to take your unit to an ECHO Service Dealer for maintenance. To help you decide whether you want to DO-IT-YOURSELF or have the ECHO Dealer do it, each maintenance task has been graded. If the task is not listed, see your ECHO Dealer for repairs.

### Skill Levels

**Level 1** = Easy to do. Common tools may be required.

**Level 2** = Moderate difficulty. Some specialized tools may be required.

ECHO offers **REPOWER™** Maintenance Kits and Parts to make your maintenance job easier.

### Maintenance Intervals

COMPONENT/SYSTEM	MAINTENANCE PROCEDURE	REQ'D SKILL LEVEL	DAILY OR BEFORE USE	EVERY REFUEL	3 MONTHS	YEARLY
Air Filter	Inspect/Clean	1	I / C *		R *	
Choke Shutter	Inspect/Clean	1	I / C			
Fuel Filter	Inspect/Replace	1			I *	I / R *
Fuel Cap Gasket	Inspect/Replace	1			I *	R *
Fuel System	Inspect/Replace	1	I (3) *	I (3) *		
Spark Plug	Inspect/Clean	1			I / C / R *	
Cooling System	Inspect/Clean	2	I / C			
Muffler Spark Arrestor	Inspect/Clean/Replace	2			I / C / R *	
Cylinder Exhaust Port	Inspect/Clean/Decarbon	2			I / C	
Drive Shaft (Flex Cable Models)	Grease	2			I (1)	
Gear Housing	Grease	2			I (2)	
Recoil Starter Rope	Inspect/Clean	1	I / C *			
Screws/Nuts/Bolts	Inspect/Tighten/Replace	1	I *			

**MAINTENANCE PROCEDURE LETTER CODES: I = INSPECT, R = REPLACE, C = CLEAN**

**IMPORTANT NOTE** - Time intervals shown are maximum. Actual use and your experience will determine the frequency of required maintenance.

#### **MAINTENANCE PROCEDURE NOTES:**

(1) Apply POWER BLENDX™ grease every 25 hours of use.

- (2) Apply POWER BLENDX™ grease every 50 hours of use.
- (3) Low evaporative fuel tanks DO NOT require regular maintenance to maintain emission integrity.

\* Replacement is recommended based on the finding of damage or wear during inspection.

## Air Filter

### Level 1.

Parts Required: REPOWER™ AIR & FUEL FILTER KIT.

1. Close choke (Cold Start Position [  ]). This prevents dirt from entering the carburetor throat when the air filter is removed. Brush accumulated dirt from air cleaner area.
2. Remove air filter cover. Brush dirt from inside cover.
3. Replace filter if it is damaged, fuel soaked, very dirty, or the rubber sealing edges are deformed.
  - Lightly brush debris from filter.
  - Soak heavily soiled filters in water/detergent solution to loosen dirt, then brush lightly.
  - Rinse with clean water and allow to dry completely before reuse.
4. Install air filter in air filter case.
5. Install air filter cover.



## Fuel Filter

### Level 1.

Parts Required: REPOWER™ AIR & FUEL FILTER KIT.

**⚠ DANGER**

***Fuel is VERY flammable. Use extreme care when mixing, storing or handling, or serious personal injury may result.***

1. Use a clean rag to remove loose dirt from around fuel cap and empty fuel tank.
2. Use a hook to pull the fuel line and filter from the tank.
3. Remove the filter from the line and install the new filter.

Note: Federal EPA regulations require all model year 2012 and later gasoline powered engines produced for sale in the United States to be equipped with a special low permeation fuel supply hose between the carburetor and fuel tank. When servicing model year 2012 and later equipment, only fuel supply hoses certified by EPA can be used to replace the original equipment supply hose. Fines up to \$37,500 may be enforced for using an un-certified replacement part.



## Spark Plug

### Level 2.

Parts Required: REPOWER™ Tune-Up Kit

### NOTICE

*Use only NGK BPM-8Y spark plug (BPMR-8Y in Canada) otherwise severe engine damage may occur.*

1. Remove spark plug and check for fouling, worn and rounded center electrode.
2. Clean the plug or replace with a new one. DO NOT sand blast to clean. Remaining sand will damage engine.
3. Adjust spark plug gap by bending outer electrode.
4. Tighten spark plug to 150-170 kgf • cm (130-150 in • lbf).

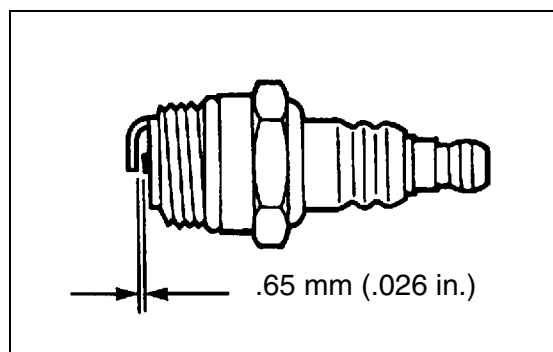

## Cooling System

### Level 2.

Parts Required: None if you are careful.

### NOTICE

*To maintain proper engine operating temperatures, cooling air must pass freely through the cylinder fin area. This flow of air carries combustion heat away from the engine.*

Overheating and engine seizure can occur when:

- Air intakes are blocked, preventing cooling air from reaching the cylinder.
- Dust and grass build up on the outside of the cylinder. This build up insulates the engine and prevents the heat from leaving.

Removal of cooling passage blockages or cleaning of cooling fins is considered "Normal Maintenance." Any failure attributed to lack of maintenance is not warranted.

1. Remove spark plug lead.

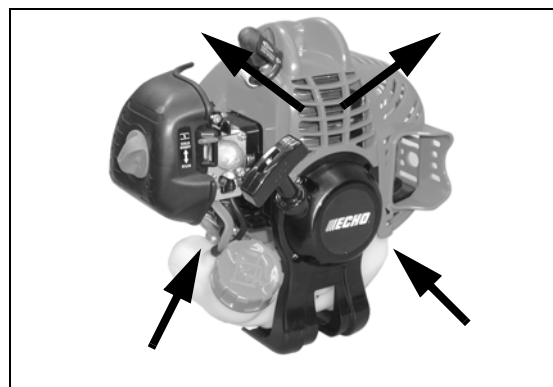

2. Remove air cleaner cover (A).
3. Remove engine cover (B).

**NOTICE**

*DO NOT use a metal scraper to remove dirt from the cylinder fins.*

4. Use brush to remove dirt from the cylinder fins.
5. Remove ignition wires from clip for cleaning.
  
6. Remove grass and leaves from the grid between the recoil starter and fuel tank.
7. Assemble components in reverse order.

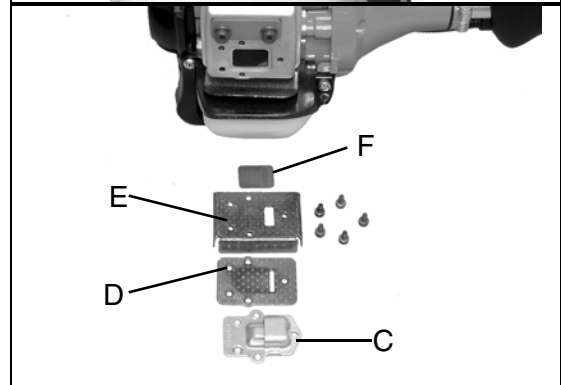
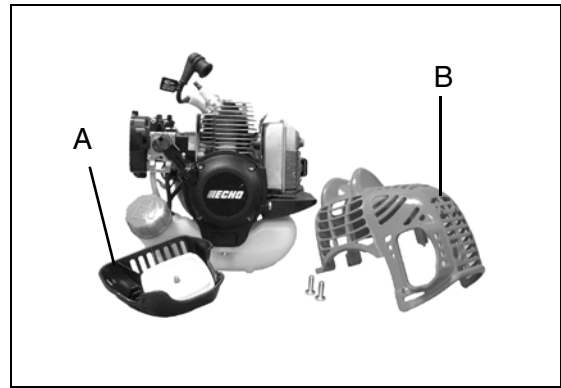

**Exhaust System**

**Spark Arrestor Screen**

**Level 2.**

Parts Required: Spark Arrestor Screen, Gasket

1. Remove engine cover (B).
2. Place piston at Top Dead Center (TDC) to prevent carbon/dirt from entering cylinder.
3. Remove spark arrestor screen cover (C), gaskets (D), (E), and screen (F), from muffler body.
4. Clean carbon deposits from muffler components.

Note: When cleaning carbon deposit, be careful not to damage the catalytic element inside muffler.

5. Replace screen if it is cracked, plugged, or has holes burned through.
6. Assemble components in reverse order.



## Exhaust Port Cleaning

### Level 2.

Parts Required: As needed: Heat Shield

1. Remove spark plug lead from spark plug, and remove engine cover.
2. Place piston at top dead center. Remove muffler (A) and heat shield (B).
3. Use a wood or plastic scraping tool to clean deposits from cylinder exhaust port.

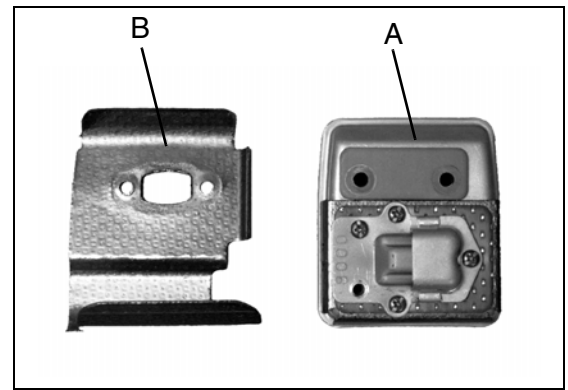

### NOTICE

*Never use a metal tool to scrape carbon from the exhaust port. Do not scratch the cylinder or piston when cleaning the exhaust port. Do not allow carbon particles to enter the cylinder.*

4. Inspect heat shield, and replace if damaged.
5. Install heat shield and muffler.
6. Tighten muffler mounting bolts (or nuts) to 80-95 in•lbf (90-110 kgf•cm).
7. Install engine cover and attach spark plug lead.
8. Start engine, and warm to operating temperature.
9. Stop engine, and re-tighten mounting bolts (or nuts) to specifications.

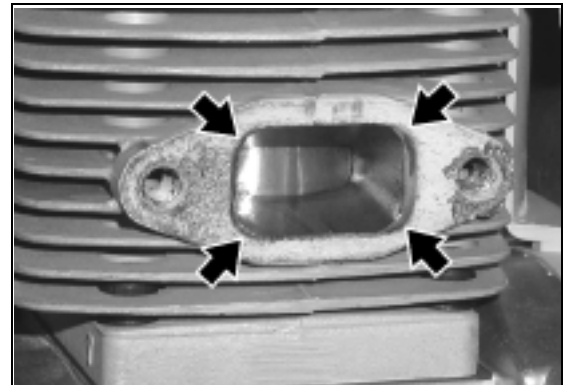

## Carburetor Adjustment

### Level 2.

#### Engine Break-In

New engines must be operated a minimum duration of two tanks of fuel break-in before carburetor adjustments can be made. During the break-in period your engine performance will increase and exhaust emissions will stabilize. Idle speed can be adjusted as required.

#### High Altitude Operation

This engine has been factory adjusted to maintain satisfactory starting, emission, and durability performance up to 1,100 feet above sea level (ASL) (96.0 kPa). To maintain proper engine operation and emission compliance above 1,100 feet ASL the carburetor may need to be adjusted by an authorized ECHO service dealer.

### NOTICE

*If the engine is adjusted for operation above 1,100 feet ASL, the carburetor must be re-adjusted when operating the engine below 1,100 feet ASL, otherwise severe engine damage may result.*

Parts Required: None

Note: Every unit is run at the factory and the carburetor is set in compliance with emission regulations. Carburetor adjustments, other than idle speed, must be performed by an authorized ECHO dealer.

1. Check idle speed and reset if necessary. If a tachometer is available, idle speed screw (A) should be set to the specifications found on “Specifications” page of this manual. Turn idle screw (A) clockwise to increase idle speed; counter clockwise to decrease idle speed.

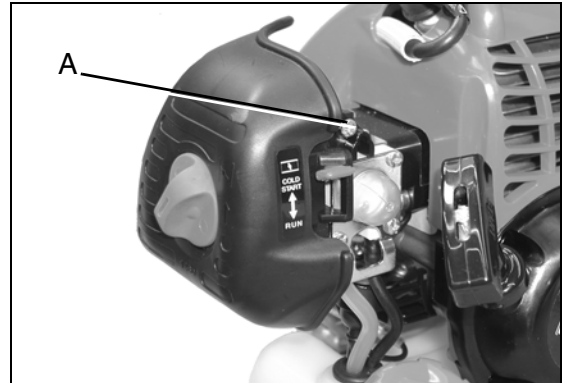

**⚠ WARNING**

***When carburetor adjustment is completed, the cutting attachment should not move at idle, otherwise serious personal injury may result.***

**Lubrication**

**Level 1.**

Parts Required: POWER BLENDX™ 8 oz. or Lithium Base Grease.



**Gear Housing**

1. Clean all loose debris from gear case.
2. Remove plug (A) and check level of grease.
3. Add grease if necessary. DO NOT over-fill.

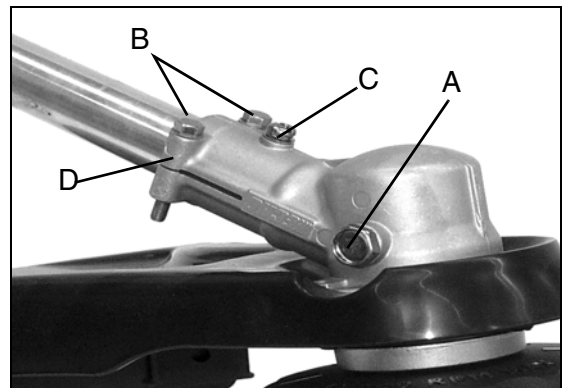

**Drive Shaft (flex cable models)**

1. Loosen two (2) screws (B) and remove center locating screw (C). Pull gear case and shield from drive shaft housing.
2. Pull flexible cable from the drive shaft housing, wipe clean and re-coat with a thin coating [15 ml (1/2 oz.)] of grease.
3. Slide the flexible cable back in the drive housing. DO NOT get dirt on the flex cable.
4. Install the gear housing and shield assembly.

**NOTICE**

*Flat edge of washers (D) must be against drive shaft.*

## Nylon Line Head Disassembly Instructions

Note: For normal use, Speed Feed® head disassembly is not necessary. However, if circumstances require disassembly, follow these instructions.

1. Press top of locking tabs (A) on both sides of Speed Feed® head to release cover (B) from eyelet carrier (C).
2. Remove cover from eyelet carrier.

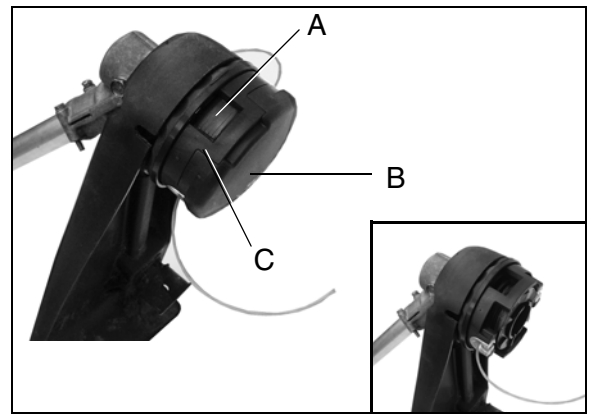

## Nylon Line Replacement



For more information scan this QR code.

### **CAUTION**

*Wear Gloves or personal injury may result:*

- *Cutoff knife is sharp.*
- *Gearcase and surrounding area may be hot.*

1. Cut one piece of line to recommended length.  
.080 (2.0 mm) dia. – 20' (6 m)  
.095 (2.4 mm) dia. – 20' (6 m)
2. Align arrows on top of knob with openings in eyelets.
3. Insert one end of trimmer line into an eyelet, and push line equal distance through trimmer head.

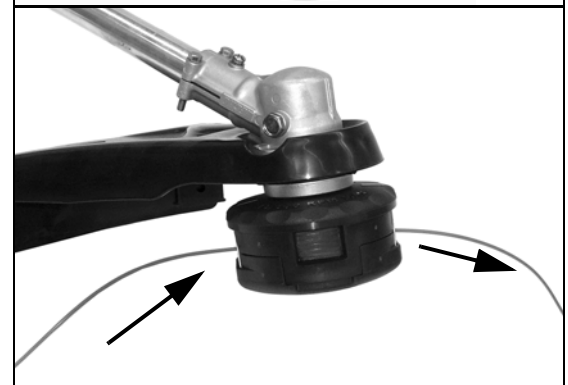

4. Hold trimmer head while turning knob clockwise to wind line onto spool until about 5" (13 cm) of each line remains exposed.

**Trimmer head is now fully loaded and ready for operation.**



**NOTICE**

When the wear indicators located at the bottom of the Speed-Feed® head are worn smooth, or if holes appear, replacement of the cover or the entire Speed-Feed® head is required.



**Sharpening Metal Blades**

Three styles of metal blades are approved for use on the ECHO Brush Cutter. The 8-tooth blade can be sharpened during normal maintenance. The clearing blade and 80 tooth blade require professional service.

Before sharpening, CLOSELY inspect blade for cracks (look at the bottom of each tooth and the center mounting hole closely), missing teeth and bending. If ANY of these problems are discovered, replace the blade.

When sharpening a blade, always remove the same amount of materials from each tooth to maintain balance. A blade that is not balanced will cause unsafe handling due to vibration and can result in blade failure.

1. File each tooth at a 30 degree angle a specific number of times, eg. 4 strokes per tooth. Work your way around the blade until all teeth are sharp.
2. DO NOT file the 'gullet' (radius) of the tooth with the flat file. The radius must remain. A sharp corner will lead to a crack and blade failure.

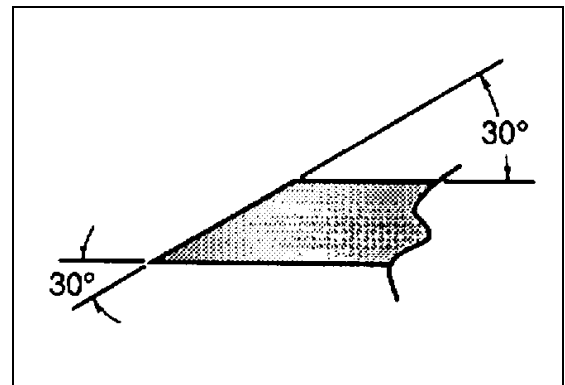
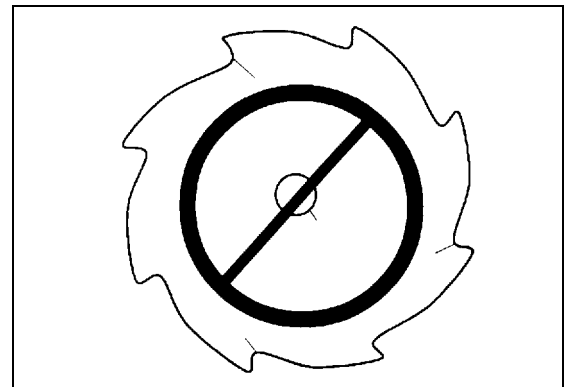

**NOTICE**

If an electric grinder is used, use care not to overheat teeth, do not allow tips/tooth to glow red or turn blue. DO NOT place blade in cooling water. This will change the temper of the blade and could result in blade failure.

- 3. After sharpening teeth, check each tooth radius for evidence of a square (sharp) corner. Use the round (rat tail) file to renew the radius.

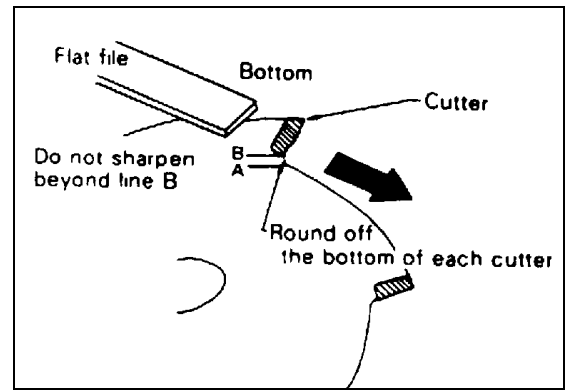

## TROUBLESHOOTING

ENGINE PROBLEM TROUBLESHOOTING CHART				
Problem	Check	Status	Cause	Remedy
Engine cranks - starts hard/ doesn't start	Fuel at carburetor	No fuel at carburetor	Fuel strainer clogged Fuel line clogged Carburetor	Clean or replace Clean or replace See your Echo dealer
	Fuel at cylinder	No fuel at cylinder	Carburetor	See your Echo dealer
		Muffler wet with fuel	Fuel Mixture too rich	Open choke Clean/replace air filter Adjust carburetor See your Echo dealer
	Spark at end of plug wire	No spark	Stop switch off Electrical problem Interlock switch	Turn switch to ON See your Echo dealer See your Echo dealer
	Spark at plug	No spark	Spark gap incorrect Covered with carbon Fouled with fuel Plug defective	Adjust to .65mm (0.026 in.) Clean or replace Clean or replace Replace plug
Engine runs, but dies or does not accelerate properly	Air filter	Air filter dirty	Normal wear	Clean or replace
	Fuel filter	Fuel filter dirty	Contaminants/residues in fuel	Replace
	Fuel vent	Fuel vent plugged	Contaminants/residues in fuel	Clean or replace
	Spark Plug	Plug dirty/worn	Normal wear	Clean and adjust or replace
	Carburetor	Improper adjustment	Vibration	Adjust
	Cooling System	Cooling system dirty/plugged	Extended operation in dirty/dusty locations	Clean
	Spark Arrestor Screen	Spark arrestor screen plugged	Normal wear	Replace
Engine does not crank	N/A	N/A	Internal engine problem	See your Echo dealer

**⚠ DANGER**

**Fuel vapors are extremely flammable and may cause fire and/or explosion. Never test for ignition spark by grounding spark plug near cylinder plug hole, otherwise serious personal injury may result.**

---

## STORAGE

---

### WARNING

*During operation the muffler or catalytic muffler and surrounding cover become hot. Always keep exhaust area clear of flammable debris during transportation or when storing, otherwise serious property damage or personal injury may result.*

### Long Term Storage (Over 30 Days)

Do not store your unit for a prolonged period of time (30 days or longer) without performing protective storage maintenance which includes the following:

1. Store unit in a dry, dust free place, out of the reach of children.

### DANGER

***Do not store in enclosure where fuel fumes may accumulate or reach an open flame or spark.***

2. Place the stop switch in the “OFF” position.
3. Remove accumulation of grease, oil, dirt and debris from exterior of unit.
4. Perform all periodic lubrication and services that are required.
5. Tighten all the screws and nuts.
6. Drain fuel tank completely. Press purge bulb 6-7 times to remove remaining fuel from carburetor then drain the tank again. Close choke, start and run the engine until it stops due to lack of fuel.
7.
  - a. Allow engine to cool then remove the spark plug and pour 7 cc (1/4 oz.) of fresh, clean, two-stroke engine oil into the cylinder through the spark plug hole.
  - b. Pull the recoil starter handle 2-3 times to distribute the oil inside the engine.
  - c. Observe the piston location through the spark plug hole. Pull the recoil handle slowly until the piston reaches the top of its travel and leave it there.
8. Install the spark plug (do not connect ignition cable).

## SPECIFICATIONS

MODEL	SRM-225
Length w/o cutter head	1793 mm (70.6 in.)
Width	251 mm (9.88 in.)
Height	328 mm (12.9 in.)
Weight (dry) w/o cutter head	5.5 kg (12.1 lb.)
Engine Type	Air cooled, two-stroke, single cylinder gasoline engine
Bore	32.2 mm (1.27 in.)
Stroke	26.0 mm (1.02 in.)
Displacement	21.2 cc (1.29 cu. in.)
Exhaust	Spark arrestor muffler or spark arrestor muffler with catalyst
Carburetor	Diaphragm w/purge pump
Ignition System	Flywheel magneto, capacitor discharge ignition type
Spark Plug	NGK BPM-8Y (Gap 0.65 mm (0.026 in.))
Fuel	Mixed (Gasoline and Two-stroke Oil)
Fuel/Oil Ratio	50 : 1 Power Blend X™ ISO-L-EGD (ISO/CD 13738) and J.A.S.O. M345- <u>FD</u> , two-stroke, air-cooled engine oil.
Gasoline	Use 89 Octane unleaded. Do not use fuel containing methyl alcohol, more than 10% ethyl alcohol or 15% MTBE. Do not use alternative fuels such as E-15 or E-85.
Oil	Power Blend X™ Premium Universal 2-Stroke Oil
Fuel Tank Capacity	0.44 lit. (14.9 US fl. oz.)
Starter System	Automatic Rewind Starter
Clutch	Centrifugal Type
Vibration Isolated System	Rubber cushion on engine mount (heavy duty). Rubber grip on front handle.
Operating Rod	25.0 mm aluminum Tube
Drive Shaft	6.35 mm (1/4 in.) flexible shaft
Gear Case Ratio	1.4:1 Reduction
Rotating Direction	Counter Clockwise; viewed from top
Cutter Head	Speed Feed® 400 LH Nylon line head, Line capacity 6.0 m (20 ft.)
Handle	Front - loop, Rear handle (w/o rubber)
Shoulder Harness	Optional
Idle Speed	2,750 RPM
Clutch Engagement Speed	3,850 RPM
Wide Open Throttle Speed (W.O.T.)	8,150 RPM



# WARRANTY STATEMENTS

## ECHO LIMITED WARRANTY STATEMENT FOR PRODUCT SOLD IN USA AND CANADA BEGINNING 01/01/2010

### ECHO'S RESPONSIBILITY

ECHO Incorporated's Limited Warranty, provides to the original purchaser that this ECHO product is free from defects in material and workmanship. Under normal use and maintenance from date of purchase, ECHO agrees to repair or replace at ECHO's discretion, any defective product free of charge at any authorized ECHO servicing dealer within listed below application time periods, limitations and exclusions. **THIS LIMITED WARRANTY IS ONLY APPLICABLE TO ECHO PRODUCTS SOLD BY AUTHORIZED ECHO DEALERS. IT IS EXTENDED TO THE ORIGINAL PURCHASER ONLY, AND IS NOT TRANSFERABLE TO SUBSEQUENT OWNERS EXCEPT FOR EMISSION RELATED PARTS.** Repair parts and accessories replaced under this warranty are warranted only for the balance of the original unit or accessory warranty period. Any damage caused by improper installation or improper maintenance is not covered by this warranty. All parts or products replaced under warranty become the property of ECHO, Inc. This warranty is separate from the Emission control warranty statement supplied with your new product. Please consult the Emission Control Warranty Statement for details regarding emission related parts. For a list of Authorized ECHO Dealers refer to [WWW.ECHO-USA.COM](http://WWW.ECHO-USA.COM) or call 1-800-432-ECHO.

### OWNER'S RESPONSIBILITY

To ensure trouble free warranty coverage it is important that you register your ECHO equipment on-line at [WWW.ECHO-USA.COM](http://WWW.ECHO-USA.COM) or by filling out the warranty registration card supplied with your unit. Registering your product confirms your warranty coverage and provides a direct link if we find it necessary to contact you.

The owner shall demonstrate reasonable care and use, and follow preventative maintenance, storage, fuel and oil usage as prescribed in the operator's manual. Should a product difficulty occur, you must, at your expense, deliver or ship your ECHO unit to an authorized ECHO servicing dealer for warranty repairs (within the applicable warranty period), and arrange for pick-up or return of your unit after the repairs have been made. For your nearest authorized ECHO servicing dealer, call ECHO's Dealer Referral Center, at 1-800-432-ECHO or you can locate an ECHO servicing dealer at [WWW.ECHO-USA.COM](http://WWW.ECHO-USA.COM). Should you require assistance or have questions concerning ECHO's Warranty Statement, you can contact our Consumer Product Support Department at 1-800-673-1558 or contact us through the web at [WWW.ECHO-USA.COM](http://WWW.ECHO-USA.COM).

### PRODUCT WARRANTY PERIOD

#### RESIDENTIAL APPLICATION

- **5 YEAR WARRANTY** - All units for residential, or non-income producing use will be covered by this limited warranty for **five (5) years** from date of purchase.

#### EXCEPTIONS:

- For two-stroke engine powered products, the electronic ignition module, flexible drive cables, SRM solid drive shafts, and TC tines are warranted for the **life\*** of the product on parts only.
- Cutting attachments such as, but not limited to, bars, chains, sprockets, blades, and nylon trimmer heads for residential or non-income producing use will be covered for failures due to defects in material or workmanship for a period of **60 days** from original product purchase date. Any misuse from contact with concrete, rocks, or other structures is not covered by this warranty.
- ECHO's Rapid Loader String Head carries a lifetime warranty on the line locking system, parts only; no labor. Refer to your operator's manual for string head installation and maintenance instructions.
- All SB-Series and PRO ATTACHMENT SERIES Split Shaft attachments carry the same warranty duration as the units they are designed to fit.

#### COMMERCIAL APPLICATION

- **1 YEAR WARRANTY** - All Chain Saws, QuikVent Saws, and Cut-Off Saws for commercial, institutional, agricultural, industrial, or income producing use will be covered by this limited warranty for one **(1) year** from the date of purchase.
- **2 YEAR WARRANTY** - All other units for commercial, institutional, agricultural, industrial, or income producing use will be covered by this limited warranty for two **(2) years** from the date of purchase.

#### EXCEPTIONS:

- For two-stroke engine powered products, the electronic ignition module, flexible drive cables, SRM solid drive shafts and TC tines, are warranted for the **life\*** of the product on parts only.
- Cutting attachments such as, but not limited to, bars, chains, sprockets, blades, and nylon trimmer heads for commercial, institutional, agricultural, industrial, rental, or income producing will be covered for failures due to defects in material or workmanship for a period of **30 days** from original product purchase date. Any misuse from contact with concrete, rocks, or other structures is not covered by this warranty.
- ECHO's Rapid Loader String Head carries a lifetime warranty on the line locking system, parts only; no labor. Refer to your operator's manual for string head installation and maintenance instructions.
- All SB-Series and PRO ATTACHMENT SERIES Split Shaft attachments carry the same warranty duration as the units they are designed to fit.

#### RENTAL APPLICATION - 90 DAYS WARRANTY

- Units for rental use will be covered against defects in material and workmanship for a period of 90 days from the date of purchase.

\* ECHO's liability under the "Lifetime" coverage is limited to furnishing parts specified under the PRODUCT WARRANTY PERIOD section of this warranty statement for "Life" free of charge for a period of ten (10) years after the date of the complete unit's final production.

**PURCHASED REPAIR PARTS, SHORT BLOCKS AND ACCESSORIES**

- 90-day residential, or non-income producing warranty
- 30-day commercial, institutional, agricultural, industrial, income producing, or rental application warranty

**ATTENTION TWO-STROKE ENGINE POWER PRODUCT OWNERS**

This ECHO two-stroke engine power product is a quality-engineered unit which has been manufactured to exact tolerances to provide superior performance. To help ensure the performance of the unit, it is required to use two-stroke oil which meets the ISO-L-EGD Standard per ISO/CD 13738 and JASO M345FD Standards. **ECHO Power Blend™ Two-Stroke Oil** is a premium two-stroke oil specifically formulated to meet ISO-L-EGD (ISO/CD 13738) and JASO M345FD Standards. The use of two-stroke oils designed for other applications, such as for outboard motors or lawnmowers can result in severe engine damage, and will void your two-stroke engine limited warranty.

**THIS WARRANTY DOES NOT COVER DAMAGE CAUSED BY:**

- Lack of lubrication or engine failure, due to the use of two-stroke oils that do not meet the ISO-L-EGD (ISO/CD 13738) and JASO M345FD Standards. Engine problems due to inadequate lubrication caused by failure to use an ISO-L-EGD compliant and JASO M345FD registered oil, will void the two-stroke engine limited warranty. **ECHO Power Blend™ Two-Stroke Oil** meets the ISO-L-EGD and JASO M345FD Standard. Emission related parts are covered for 5 years residential use or 2 years commercial use regardless of two-stroke oil used, per the statement listed in the EPA or California Emission Defect Warranty Explanation.
- Damage caused by use of gasohol, containing methanol (wood alcohol), or gasoline containing less than 89 octane. Only use gasoline which contains 89 octane or higher. Gasohol which contains a **maximum** 10% ethanol (grain alcohol) or 15% MTBE (methyl/tertiary/butyl/ether) is also approved. The prescribed mixing ratio of gasoline to oil is listed on the ECHO oil label and covered in your operator's manual.
- Engine damage caused by use of ether or any starting fluids.
- Damage caused by tampering with engine speed governor or emission components, or running engines above specified and recommended engine speeds as listed in your operator's manual.
- Operation of the unit with improperly maintained/removed cutting shield or removed/damaged air filter.
- Damage caused by dirt, pressure or steam cleaning the unit, salt water, corrosion, rust, varnish, abrasives, and moisture.
- Defects, malfunctions or failures resulting from abuse, misuse, neglect, modifications, alterations, normal wear, improper servicing, or use of unauthorized attachments.
- Incorrect storage procedures, stale fuel, including failure to provide or perform required maintenance services as prescribed in the operator's manual. Preventative maintenance as outlined in the operators manual is the customer's responsibility.
- Failures due to improper set-up, pre-delivery service or repair service by anyone other than authorized ECHO servicing dealer during the warranty period.
- Certain parts and other items are not warranted, including but not limited to: lubricants, starter cords, and engine tune-ups.
- Use of spark plugs other than those meeting performance and durability requirements of the OEM spark plug listed in the Operator's Manuals.
- Overheating or carbon scoring failures due to restricted, clogged exhaust port or combustion chamber, including damage to spark arrester screen.
- Adjustments after the first (30) thirty days and beyond, such as carburetor adjustment and throttle cable adjustment.
- Damage to gears or gear cases caused by contaminated grease or oil, use of incorrect type or viscosity of lubricants, and/or failure to comply with recommended grease or oil change intervals.
- Damage caused by loading SHRED 'N' VAC® beyond recommended capacity.
- Damage caused by pump or sprayer running dry, pumping or spraying caustic or flammable materials, or lack of or broken strainers.
- Additional damage to parts or components due to continued use after operational problem or failure occurs. Should operational problem or failure occur, the product should not be used, but delivered as is to an authorized ECHO servicing dealer.

It is a dealer's and/or customer's responsibility to complete and return the warranty registration card supplied with your ECHO product or by visiting [WWW.ECHO-USA.COM](http://WWW.ECHO-USA.COM). Your receipt of purchase including date, model and serial number must be maintained and presented to an authorized ECHO servicing dealer for warranty service. Proof of purchase rests solely with the customer. Some states do not allow limitations on how long an implied warranty lasts, so the above limitations may not apply to you. Some states do not allow the exclusion or limitation of incidental or consequential damages, so you may also have other specific legal rights which vary from state to state. This limited warranty is given by ECHO Incorporated, 400 Oakwood Rd., Lake Zurich, IL 60047.

**DISCLAIMER OF IMPLIED WARRANTIES**

This limited warranty is in lieu of all other expressed or implied warranties, including any warranty of FITNESS FOR A PARTICULAR PURPOSE OR USE and any implied warranty of **MERCHANTABILITY** otherwise applicable to this product. ECHO and its affiliated companies shall not be liable for any special incidental or consequential damage, including lost profits. There are no warranties extended other than as provided herein. This limited warranty may be modified only by ECHO.

99922201032  
11/18/2011

NOTES

---



**ECHO, INCORPORATED**

400 Oakwood Road  
Lake Zurich, IL 60047

[www.echo-usa.com](http://www.echo-usa.com)

S04011051023/S04011999999  
S96811001001/S96811999999  
S03912425291/S03912999999  
S89312001001/S89312999999