



Power Blower

Operator's Manual

MODEL

PB-603

Serial Number 03001001 - 03999999

WARNING  **DANGER**



The muffler or catalytic muffler and surrounding cover may become extremely hot.

Always keep clear of exhaust and muffler area, otherwise serious personal injury may occur.



WARNING



The engine exhaust from this product contains chemicals known to the State of California to cause cancer, birth defects or other reproductive harm.



WARNING  **DANGER**

Read rules for safe operation and all instructions carefully. ECHO provides this Operator's Manual, which must be read and understood for proper and safe operation.

INTRODUCTION

Welcome to the ECHO family. This ECHO product was designed and manufactured to provide long life and on-the-job dependability. Read and understand this manual. You will find it easy to use and full of helpful operating tips and SAFETY messages.

THE OPERATOR'S MANUAL

Read and understand this manual before operation. Keep it in a safe place for future reference. It contains specifications and information for operation, starting, stopping, maintenance, storage, and assembly specific to this product.

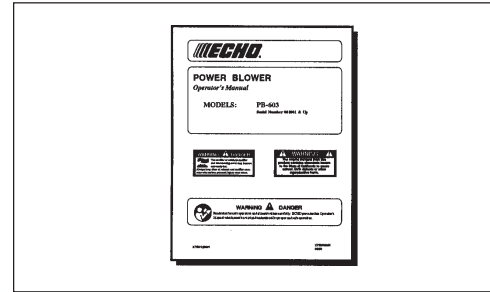



TABLE OF CONTENTS

Introduction	2	- Stopping Engine	13
- The Operator's Manual	2	- Operating Blower	14
Manual Safety Symbols and Important Information ..	3	Maintenance	14
Safety	3	- Skill Levels	14
- Decals	3	- Maintenance Intervals	15
- International Symbols	4	- Air Filter	16
Safety Instructions	4	- Fuel Filter	16
- Personal Condition and Safety Equipment	4	- Spark Plug	17
- Extended Operation/Extreme Conditions	5	- Cooling System	17
- Equipment	5	- Exhaust System	18
- Safe Operation	6	- Carburetor Adjustment	19
Emission Control	6	Troubleshooting	21
Description	7	Storage	22
- Contents	7	Servicing Information	24
Specifications	9	- Parts	24
Assembly	10	- Service	24
- Install Blower Pipes	10	- ECHO Consumer Product Support	24
Pre-Operation	11	- Warranty Registration	24
- Fuel	11	- Additional or Replacement Manuals	24
Operation	12		
- Starting Cold Engine	12		
- Starting Warm Engine	13		

Specifications, descriptions and illustrative material in this literature are as accurate as known at the time of publication, but are subject to change without notice. Illustrations may include optional equipment and accessories, and may not include all standard equipment.

MANUAL SAFETY SYMBOLS AND IMPORTANT INFORMATION

Throughout this manual and on the product itself, you will find safety alerts and helpful informational messages preceded by symbols or key words. The following is an explanation of those symbols and key words, and what they mean to you.



This symbol accompanied by the words **WARNING** and **DANGER** calls attention to an act or condition that can lead to serious personal injury to operator and bystanders.



The circle with the slash symbol means whatever is shown within the circle is prohibited.



IMPORTANT **NOTE**

IMPORTANT The enclosed message provides information necessary for the protection of the unit.

NOTE This enclosed message provides tips for use, care and maintenance of the unit.

SAFETY

DECALS

Locate these safety decals on your unit. Make sure the decals are legible and that you understand and follow the instructions on them. If a decal cannot be read, a new one can be ordered from your ECHO dealer. See PARTS ORDERING instructions for specific information.

Hot Decal (near muffler)

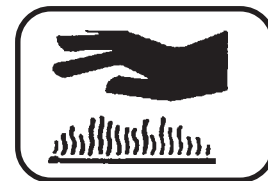

P/N 89016006361

General Warning Decal (located on top of blower housing)



P/N 89016009461

Sound Label (located on blower housing)



P/N X508000150

INTERNATIONAL SYMBOLS

SYMBOL	DESCRIPTION	SYMBOL	DESCRIPTION
	Read and understand Operator's Manual.		Fuel and oil mixture
	Wear eyes, ears and head protection		Finger Severing
	Hot Surface		Wear hand protection. Use two handed.
	Safety/Alert		Wear slip resistant foot wear.
	DO NOT allow flames or sparks near fuel.		DO NOT smoke near fuel.

SYMBOL	DESCRIPTION	SYMBOL	DESCRIPTION
	Ignition ON/OFF		Primer Bulb
	Emergency Stop		Choke Control "Cold Start" Position (Choke Closed)
	Carburetor Adjustment - High speed mixture		Choke Control "Run" Position (Choke Open)
	Carburetor adjustment - Low speed mixture		Carburetor Adjustment - Idle speed

SAFETY INSTRUCTIONS

PERSONAL CONDITION AND SAFETY EQUIPMENT

WARNING DANGER

Power Blower users risk injury to themselves and others if the power blower is used improperly or safety precautions are not followed. Proper clothing and safety gear must be worn when operating a blower.

Physical Condition

Your judgment and physical dexterity may not be good:

- if you are tired or sick,
- if you are taking medication,
- if you have taken alcohol or drugs.

Operate unit only if you are physically and mentally well.

Eye Protection

Wear eye protection that meets ANSI Z87.1 or CE requirements whenever you operate the unit.

Hand Protection

Wear no-slip, heavy duty work gloves to improve your grip on the blower handle. Gloves also reduce the transmission of machine vibration to your hands.

Breathing Protection

Wear a face mask to protect against dust.

Hearing Protection

ECHO recommends wearing hearing protection whenever unit is used.

Proper Clothing

Wear snug fitting, durable clothing;

- Pants should have long legs, shirts with long sleeves.
- **DO NOT WEAR SHORTS,**
- **DO NOT WEAR TIES, SCARVES, JEWELRY.**

Wear sturdy work shoes with nonskid soles;

- **DO NOT WEAR OPENTOED SHOES,**
- **DO NOT OPERATE UNIT BAREFOOTED.**

Keep long hair away from engine and blower intake. Retain hair with cap or net.

Hot Humid Weather

Heavy protective clothing can increase operator fatigue which may lead to heat stroke. Schedule heavy work for early morning or late afternoon hours when temperatures are cooler.

EXTENDED OPERATION/EXTREME CONDITIONS

Vibration and Cold

It is believed that a condition called Raynaud's Phenomenon, which affects the fingers of certain individuals, may be brought about by exposure to vibration and cold. Exposure to vibration and cold may cause tingling and burning sensations, followed by loss of color and numbness in the fingers. The following precautions are strongly recommended because the minimum exposure which might trigger the ailment is unknown.

- Keep your body warm, especially the head, neck, feet, ankles, hands, and wrists.
- Maintain good blood circulation by performing vigorous arm exercises during frequent work breaks, and also by not smoking.
- Limit the hours of operation. Try to fill each day with jobs where operating the unit or other hand-held power equipment is not required.
- If you experience discomfort, redness, and swelling of the fingers, followed by whitening and loss of feeling, consult your physician before further exposing yourself to cold and vibration.

Repetitive Stress Injuries

It is believed that overusing the muscles and tendons of the fingers, hands, arms, and shoulders may cause soreness, swelling, numbness, weakness and extreme pain in those areas. Certain repetitive hand activities may put you at a high risk for developing a Repetitive Stress Injury (RSI). An extreme RSI condition is Carpal Tunnel Syndrome (CTS), which could occur when your wrist swells and squeezes a vital nerve that runs through the area. Some believe that prolonged exposure to vibration may contribute to CTS. CTS can cause severe pain for months or even years.

To reduce the risk of RSI/CTS, do the following:

- Avoid using your wrist in a bent, extended, or twisted position. Instead try to maintain a straight wrist position. Also, when grasping, use your whole hand, not just the thumb and index finger.
- Take periodic breaks to minimize repetition and rest your hands.
- Reduce the speed and force with which you do the repetitive movement.
- Do exercises to strengthen the hand and arm muscles.
- Immediately stop using all power equipment, and consult a doctor if you feel tingling, numbness or pain in the fingers, hands, wrists, or arms. The sooner RSI/CTS is diagnosed, the more likely permanent nerve and muscle damage can be prevented.

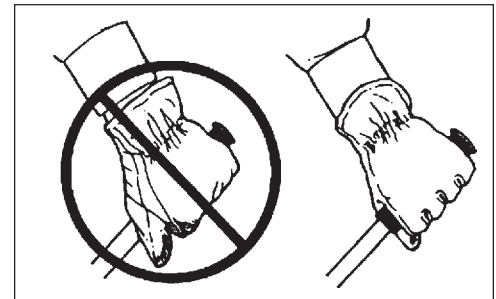

EQUIPMENT

Before operation a complete check of the unit must be performed:

- Check unit for loose/missing nuts, bolts and screws. Tighten and/or replace as needed.
- Inspect fuel lines, tank and area around carburetor for fuel leaks. **DO NOT** operate unit if leaks are found.
- Keep exhaust area clear of flammable debris. Avoid contact during and immediately after operation.

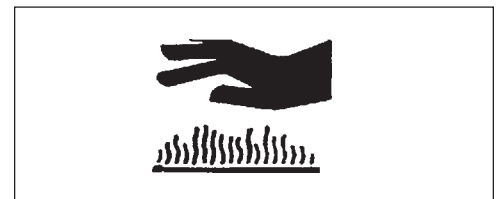

SAFE OPERATION

WARNING DANGER

Do not operate this product indoors or in inadequately ventilated areas. Engine exhaust contains poisonous emissions and can cause serious injury or death.

Determine Operation Area

- Review area to be cleared. Look for potential hazards such as stones or metal objects.
- Take wind conditions into account: avoid open doors and windows.
- Do not point blower at people or animals.
- Start unit on ground with throttle at idle. Check that blower pipe is not blocked by the ground or by any objects.

Read the Manuals

- Provide all users of this equipment with the Operator's Manual and Safety Manual for instructions on Safe Operation.

Keep A Firm Grip

- Hold handle with fingers together encircling the handle.

Clear the Work Area

- Spectators and fellow workers must be warned, and children and animals prevented from coming nearer than 15 m (50 ft.) while the unit is in use.

Keep A Solid Stance

- Maintain footing and balance at all times. Do not stand on slippery, uneven or unstable surfaces. Do not work in odd positions or on ladders.
- Do not perform Maintenance or Assembly procedures with engine running.

Noise Control

- Follow local noise regulations on sound levels and hours of operations. Use only during appropriate hours.
- Never use a higher speed setting than necessary to perform a task. The higher the engine speed the louder the blower noise.
- Be a good neighbor.

Avoid Hot Surfaces

- During operation, the muffler or catalytic muffler and surrounding cover may become extremely hot. Avoid contact during and immediately after operation. Always keep exhaust area clear of flammable debris. Allow the engine and muffler to completely cool before performing any maintenance activity.

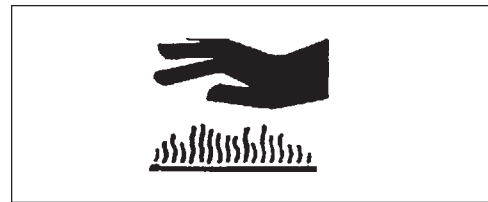

EMISSION CONTROL

EPA Phase 1

The emission control system for this engine is EM (Engine Modification).

An Emission Control Label is located on the unit. (This is an EXAMPLE ONLY, information on label varies by engine FAMILY).

IMPORTANT ENGINE INFORMATION

ENGINE FAMILY: 3EHXS.0585RA

DISPLACEMENT: 58.2 cc

THIS ENGINE MEETS U.S. EPA PH1 EMISSION REGULATIONS FOR SMALL NON ROAD ENGINES. REFER TO OWNER'S MANUAL FOR MAINTENANCE SPECIFICATIONS AND ADJUSTMENTS.



KIORTZ CORP. 

PRODUCT EMISSION DURABILITY



The 300 hour emission durability compliance period is the time span selected by the manufacturer certifying the engine emissions output meets applicable emissions regulations, provided that approved maintenance procedures are followed as listed in the Maintenance Section of this manual.

DESCRIPTION

CONTENTS

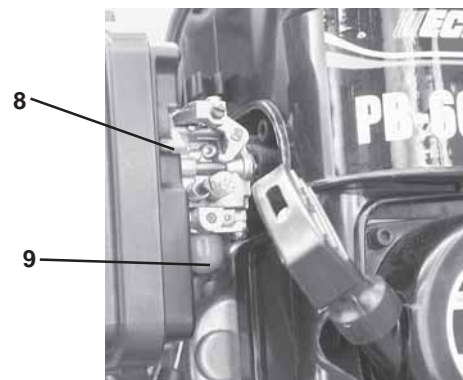
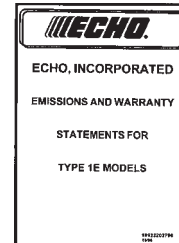
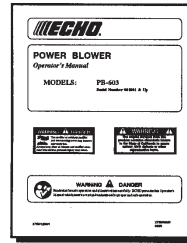
- ___ 1 - Power Head
- ___ 1 - Flex Pipe
- ___ 1 - Pipe w/swivel
- ___ 1 - Straight Pipe
- ___ 1 - Straight Pipe w/decal
- ___ 1 - Operator's Manual
- ___ 1 - Warranty Registration Card
- ___ 1 - ECHO Emissions and Warranty Statement
- ___ 1 - Plastic Bag
- ___ 2 - Clamps w/screws
- ___ 2 - Cable Ties
- ___ 1 - Echo Power Blend™ 2-stroke oil sample



1. **SAFETY DECAL** - Lists important safety precautions.
2. **SPARK PLUG** - Provides spark to ignite fuel mixture.
3. **SPARK ARRESTOR - CATALYTIC MUFFLER/MUFFLER** - The muffler or catalytic muffler controls exhaust noise and emission. The spark arrestor screen prevents hot, glowing particles of carbon from leaving the muffler. Keep exhaust area clear of flammable debris.
4. **RECOIL STARTER HANDLE** - Pull recoil handle slowly until starter engages, then quickly and firmly. When engine starts, return handle slowly. **DO NOT** let handle snap back, or damage to unit will occur.
5. **AIR CLEANER** - Contains replaceable air filter element.
6. **FUEL TANK CAP** - Covers and seals fuel tank.
7. **SHOULDER HARNESS** - Used to support unit on operator's back. The straps are adjustable.
8. **CHOKE** - Choke is located on the side of the air cleaner. Move choke lever to "COLD START"  to close choke for cold starting. Move choke lever to "RUN"  position to open choke.
9. **PRIMER BULB** - Pumping primer bulb before starting engine draws fresh fuel from the fuel tank, priming the carburetor for starting. Pump primer bulb until fuel is visible and flows freely in the clear fuel tank return line. Pump bulb an additional 4 or 5 times.
10. **LOCKING KNOB** - Allows operator to adjust handle position for optimum comfort and control.
11. **HANDLE** - Used by operator to direct and control air flow.
12. **THROTTLE POSITION LEVER** - Pull back to increase engine speed. Friction washers maintain throttle lever setting.
13. **STOP SWITCH** - Slide switch mounted on top of handle. Move forward to run, back to stop.
14. **THROTTLE TRIGGER** - Spring loaded to return to idle when released. During acceleration, press trigger gradually for best operating technique.
15. **BLOWER PIPES** - Twist-lock design.
16. **FLEXIBLE PIPE** - Allows for full range of movement.

SPECIFICATIONS

MODEL	PB-603
Length	320mm(12.6in.)
Width	460mm (18.1 in.)
Height	480 mm (18.9 in.) (in blower configuration w/side handle)
Weight (dry)	8.7 kg (19.3 lb.)
Engine Type	Air cooled, two-stroke, single cylinder gasoline engine
Displacement	58.2 cc (3.56 cu. in.)
Bore	46.0mm(1.81 in.)
Stroke	35.0mm(1.38in.)
Carburetor	Zama Diaphragm, model C1M w/primer bulb
Ignition System	Flywheel Magneto, capacitor discharge ignition type
Spark Plug	NGK BPM-7Y Gap0.65 mm(0.026 in.)
Exhaust System	Spark Arrestor Muffler
Fuel	Mixed (Gasoline and Two-stroke Oil)
Fuel/Oil Ratio	50:1 two-stroke air cooled engine oil
Gasoline	89 Octane unleaded. DO NOT use fuel containing methyl alcohol, more than 10% ethyl alcohol or 15% MTBE.
Oil	Power Blend™ Premium Universal 2-Stroke Oil
Fuel Tank Capacity	1.9 lit. (64.3 US fl. oz.)
Recoil Starter System	Automatic Recoil Starter Centrifugal Type
Idle Speed	2,300 - 3,200 (RPM)
Wide Open Throttle Speed	7,000 - 8,000 (RPM)
Maximum Air Speed (Measured at pipe end)	306 KM/H (190 mph)
Average Air Volume (Measured at pipe end)	15.1 cu. m/min. (535 cu. ft./min.)
Sound Level at 50 ft. dB(A) scale per ANSIB175.2	72 dB(A)

ASSEMBLY

WARNING DANGER

Never perform maintenance or assembly procedures with engine running, or serious personal injury may result.

INSTALL BLOWER PIPES

1. Assemble clamps (A) onto both ends of flexible pipe (B).
2. Assemble straight pipe with swivel (C) into flexible pipe (B).

NOTE

Assure throttle cable is not kinked or twisted before assembly.

3. Position throttle cable so it passes between the elbow (G) and frame and runs along the top of the flexible pipe. Remove clamp screw (D) on handle (E). Spread clamp and install onto straight pipe with swivel (C).
4. Assemble flexible pipe (B) to elbow (G) on blower.

NOTE

A light lubricant may be used to ease assembly of flexible pipe to blower elbow.

5. Tighten clamps (A).
6. Install throttle cable ties (F) in grooves at each end of flexible pipe.
7. Move handle (E) to desired position. Tighten knob (H) hand tight and tighten clamp screw (D).

NOTE

Check throttle for freedom of movement and that wide open throttle/low idle extremes are adjusted properly, if not, consult your Echo Dealer.

8. Assemble straight pipe (J) to pipe with swivel (C), turning straight pipe counter-clockwise to lock in place. Assemble straight pipe (K) to straight pipe (J) the same way.
9. Make sure all clamps are tight.

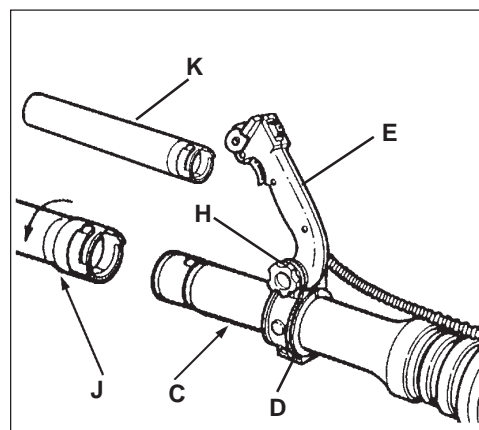
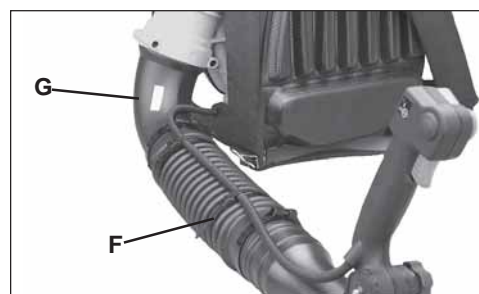
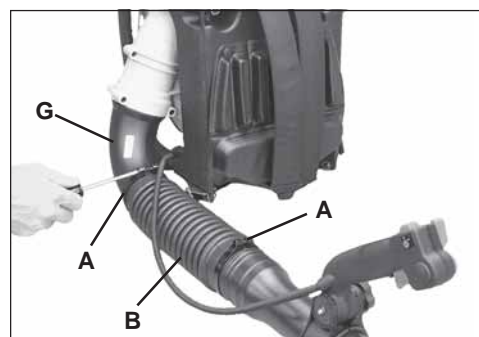
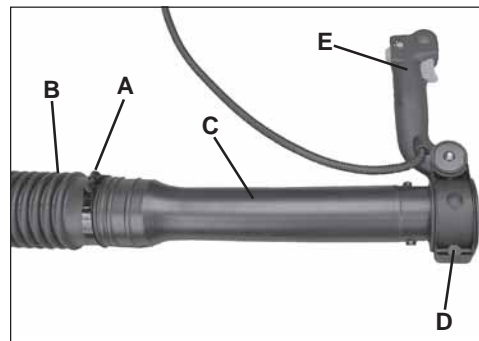

PRE-OPERATION

FUEL

Fuel Requirements

Gasoline - Use 89 Octane [R+M/2] (mid grade or higher) gasoline known to be good quality. Gasoline may contain up to 15% MTBE (methyl tertiary-butyl ether). Gasohol containing methyl (wood) alcohol is **NOT** approved.

Two Stroke Oil - A two-stroke engine oil meeting ISO-L-EGD (ISO/CD 13738) and J.A.S.O. FC Standards must be used. Echo brand premium Power Blend™ Universal 2-Stroke Oil meets these standards. Engine problems due to inadequate lubrication caused by failure to use an ISO-L-EGD and J.A.S.O. FC certified oil, such as Echo premium Power Blend™, will void the two-stroke engine warranty. (Emission related parts only are covered for two years, regardless of two-stroke oil used, per the statement listed in the Emission Defect Warranty Explanation.)

IMPORTANT

Echo premium Power Blend™ Universal 2-Stroke Oil may be mixed at 50:1 ratio for application in all Echo engines sold in the past regardless of ratio specified in those manuals.

Mixing Instructions

1. Fill an approved fuel container with half of the required amount of gasoline.
2. Add the proper amount of 2-stroke oil to gasoline.
3. Close container and shake to mix oil with gasoline.
4. Add remaining gasoline and remix.
5. Install fuel container cap and wipe any spilled fuel from container and surrounding area.

Handling Fuel

WARNING



DANGER

Fuel is **VERY** flammable. Use extreme care when mixing, storing or handling or serious personal injury may result.

- Use an approved fuel container.
- **DO NOT** smoke near fuel.
- **DO NOT** allow flames or sparks near fuel.
- Fuel tanks/cans may be under pressure. Always loosen fuel caps slowly allowing pressure to equalize.
- **NEVER** refuel a unit when the engine is **HOT!**
- **NEVER** refuel a unit with the engine running.
- **DO NOT** fill fuel tanks indoors. **ALWAYS** fill fuel tanks outdoors over bare ground.
- Securely tighten fuel cap after refueling.
- Inspect for fuel leakage. If fuel leakage is found, do not start or operate unit until leakage is repaired.

IMPORTANT

Spilled fuel is a leading cause of hydrocarbon emissions. Some states may require the use of automatic fuel shut-off containers to reduce fuel spillage. Contact your ECHO dealer for ordering information.

After Refueling

- Wipe any spilled fuel from the unit.
- Move at least 3 m (10 ft.) from refueling location before starting.

After use

- **DO NOT** store a unit with fuel in its tank. Leaks can occur. Return unused fuel to an approved fuel storage container.

Storage

Fuel storage laws vary by locality. Contact your local government for the laws affecting your area. As a precaution, store fuel in an approved, air tight container. Store in a well ventilated, unoccupied building, away from sparks and flames. Do not store fuel longer than 30 days.

IMPORTANT

Stored fuel ages. Do not mix more fuel than you expect to use in thirty (30) days, ninety (90) days when a fuel stabilizer is added.

Stored two-stroke fuel may separate. **ALWAYS** shake fuel container thoroughly before each use.

OPERATION

- Check unit for loose nuts, bolts, and screws daily.
- Recoil starter: Use short pulls - only 1/2-2/3 of rope length for starting. Do not allow the rope to snap back in. Always hold the unit firmly.

STARTING COLD ENGINE

1. *Throttle Lever/Stop Switch*
Move throttle lever (A) forward to idle position. Slide stop switch (B) forward to run position.
2. *Choke*
Move choke (C) up to Cold Start position (↵).
3. *Primer*
Pump primer bulb (D) until fuel is visible and flows freely in the clear fuel tank return line. Pump bulb an additional 4 or 5 times.
4. *Recoil Starter*
Pull recoil starter handle (E) until engine fires (5 pulls maximum).
5. *Choke*
Move choke (C) down to run position (⇓), and if necessary, restart engine.

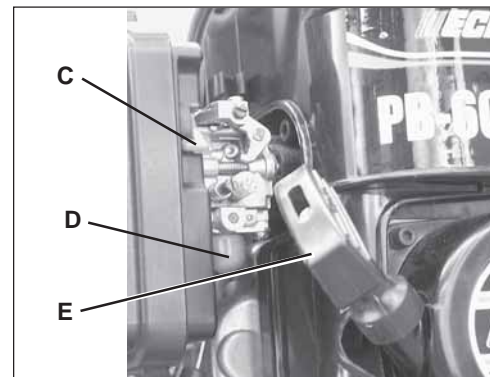
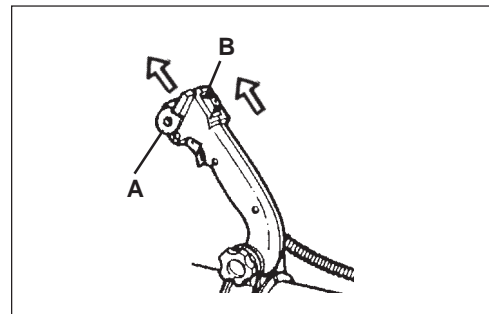

NOTE

If engine does not start after 5 pulls, move choke to "Cold Start" position, and repeat steps 4 & 5.

NOTE

Allow engine to warm up before use.

STARTING WARM ENGINE

The starting procedure is the same as Cold Start except DO NOT close the choke.

1. *Throttle Lever/Stop Switch*
Move throttle lever (A) forward to idle position. Slide stop switch (B) forward to run position.

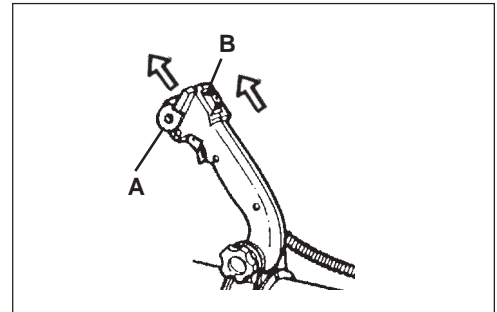

2. *Primer*
Pump primer bulb (D) until fuel is visible and flows freely in the clear fuel tank return line. Pump bulb an additional 4 or 5 times.
3. *Recoil Starter*
Pull recoil starter handle (E) and engine should start.

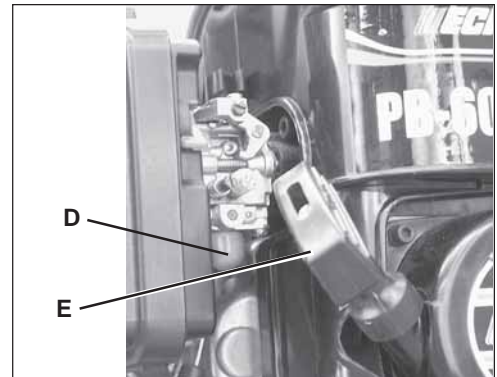

NOTE

If engine does not start after 5 pulls, use cold start procedures.

STOPPING ENGINE

1. *Throttle Lever*
Move throttle lever (A) forward to idle position and allow engine to return to idle before shutting off engine.
2. *Stop Switch*
Slide stop switch (B) to Stop position.

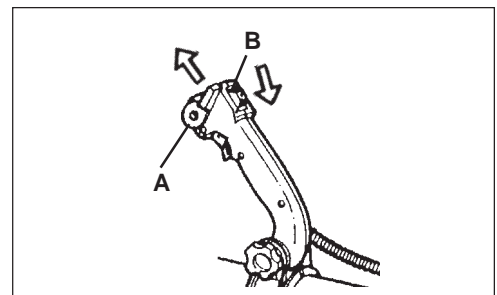

WARNING  **DANGER**

If engine does not stop when stop switch is moved to STOP position, close choke - COLD START position - to stall engine. Have your ECHO dealer repair stop switch before using blower again.

OPERATING BLOWER

WARNING



DANGER

Always wear safety glasses, hearing protection, a face filter mask, and take all safety precautions, or serious personal injury may result.

Do not point the blower pipe in the direction of people or pets.

Read the Safety Section carefully.

IMPORTANT

To avoid engine damage due to over-revving, do not block blower pipe opening.

1. Use only during appropriate hours.
2. Allow the engine to warm up at a fast idle for a few minutes.
3. Set engine speed with throttle lever (A).
4. Use lower speed to blow dry leaves from a lawn or flower bed.
5. Additional speed may be necessary to clean grass and leaves from walks, patios and drives.
6. Higher speed may be necessary to move gravel, dirt, snow, bottles or cans from a driveway, street, parking lot or stadium.

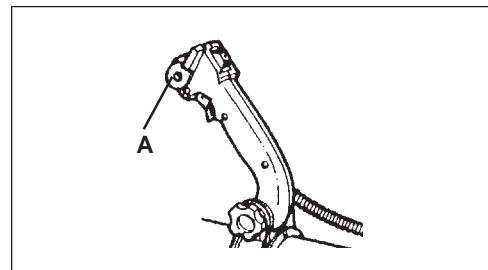

NOTE

Never use a higher speed setting than necessary to perform a task. Remember, the higher the engine speed, the louder the blower noise. Minimize dust by using blower at lower speeds and by dampening material with water/mist when necessary. Keep debris on your property.
Be Smart - be a good neighbor.

MAINTENANCE

Your ECHO blower is designed to provide many hours of trouble-free service. Regular scheduled maintenance will help your blower achieve that goal. If you are unsure or are not equipped with the necessary tools, you may want to take your unit to an ECHO Service Dealer for maintenance. To help you decide whether you want to DO-IT-YOURSELF or have the ECHO Dealer do it, each maintenance task has been graded. If a task is not listed, see your ECHO Dealer for repairs.

SKILL LEVELS

- Level 1** = Easy to do. Most required tools come with unit.
- Level 2** = Moderate difficulty. Some specialized tools may be required.
- Level 3** = Experience required. Specialized tools are required. Echo recommends the unit be returned to your Echo Dealer for servicing.

ECHO offers **REPOWER**[™] Maintenance Kits and Parts to make your maintenance job easier. The various part numbers required for each task are listed below the task heading. See your ECHO dealer for these parts.

MAINTENANCE INTERVALS

COMPONENT/ SYSTEM	MAINTENANCE PROCEDURE	REQ'D SKILL LEVEL	DAILY OR BEFORE USE	EVERY REFUEL	3 MONTHS OR 90 HOURS	6 MONTHS OR 270 HOURS	YEARLY
Recommended Echo Dealer Maintenance Procedures							
Cylinder Exhaust Port	Inspect/Clean/Decarbon	3			I / C		
Do-It-Yourself Maintenance Procedures							
Air Filter	Inspect/Clean/Replace	1	I / C		R*		
Choke	Inspect/Clean	2	I / C				
Fuel Filter	Inspect/Replace	1			I		R*
Fuel System, Leaks	Inspect/Replace	1	I	I / R*			
Cooling System	Inspect/Clean	2	I / C				
Muffler Spark Arrestor	Inspect/Replace	2			I / R*		
Recoil Starter Rope	Inspect/Clean	1	I / C				I / R*
Spark Plug	Inspect/Clean	2			I / C	R*	
Screws/Nuts/Bolts	Inspect/Tighten/Replace	1	I / R*				
<p>MAINTENANCE PROCEDURE LETTER CODES: I = INSPECT, R = REPLACE, C = CLEAN IMPORTANT NOTE - Time intervals shown are maximum. Actual use and your experience will determine the frequency of required maintenance. MAINTENANCE PROCEDURE NOTES: * All recommendations to replace are based on the finding of damage or wear during inspection.</p>							

AIR FILTER

Level 1.

Tools required: 25 - 50 mm (1 - 2 in.) Cleaning brush.

Parts required: REPOWER™ Tune Up Kit P/N 90072

NOTE

Clean daily.

1. Close choke (Cold Start Position ). This prevents dirt from entering the carburetor throat when the air filter is removed. Brush accumulated dirt from the air cleaner area.
2. Remove the air cleaner cover. Clean and inspect the element for damage. If element is fuel soaked and very dirty, replace.
3. If element can be cleaned and reused, be certain it:
 - still fits the cavity in the air cleaner cover.
 - is installed with the original side out.

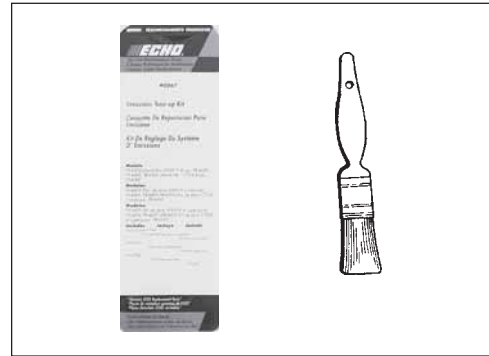

FUEL FILTER

Level 1.

Tools required: 200-250 mm (8 - 10 in.) length of wire with one end bent into a hook, clean rag, funnel, and an approved fuel container.

Parts required: REPOWER™ Tune Up Kit P/N 90072

WARNING DANGER

Fuel is **VERY** flammable. Use extreme care when mixing, storing or handling.

1. Use a clean rag to remove loose dirt from around fuel cap and empty fuel tank.
2. Use the “fuel line hook” to pull the fuel line and filter from the tank.
3. Remove the filter from the line and install the new filter.



SPARK PLUG

Level 1.

Tools required: 19 mm Spark Plug deep socket, feeler gauge

Parts Required: REPOWER™ Tune Up Kit P/N 90072

1. Remove spark plug, and check for fouling, and worn or rounded center electrode.
2. Clean the plug or replace with a new one. DO NOT sand blast to clean. Remaining sand will damage engine.
3. Adjust spark plug gap by bending outer electrode.
4. Tighten spark plug to 145-155 kg/cm (125-135 in. lb.).

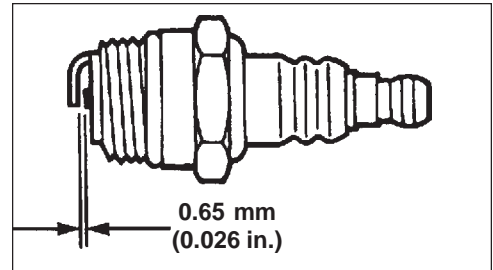
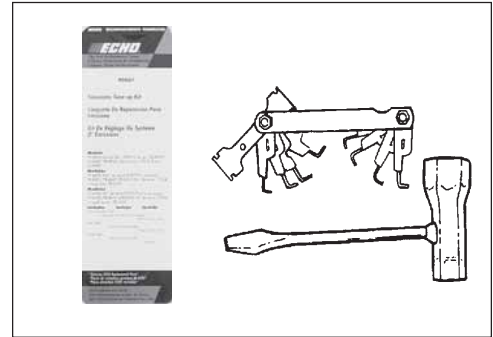

COOLING SYSTEM

Level 2.

Tools required: 25 - 50 mm (1 - 2 in.) cleaning brush, cross head screwdriver

Parts Required: None, if you are careful.

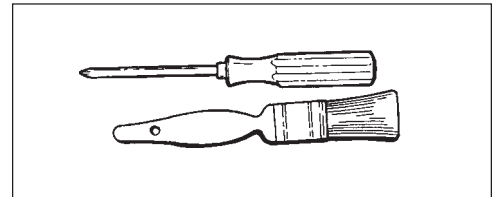

IMPORTANT

To maintain proper engine operating temperatures, cooling air must pass freely through the cylinder fin area. This flow of air carries combustion heat away from the engine.

Overheating and engine seizure can occur when:

- Air intakes are blocked, preventing cooling air from reaching the cylinder.
- Dust and grass build up on the outside of the cylinder. This build up insulates the engine and prevents the heat from leaving.

Removal of cooling passage blockages or cleaning of cooling fins is considered "Normal Maintenance." Any failure attributed to lack of maintenance is not warranted.

Cleaning Grill

1. Remove accumulated debris from intake grill between backpack frame and blower housing.



Cleaning Cylinder Fins

1. Remove engine cover (five screws), pull cover away from engine. Clean cylinder fins (B) to allow cooling air to pass freely.

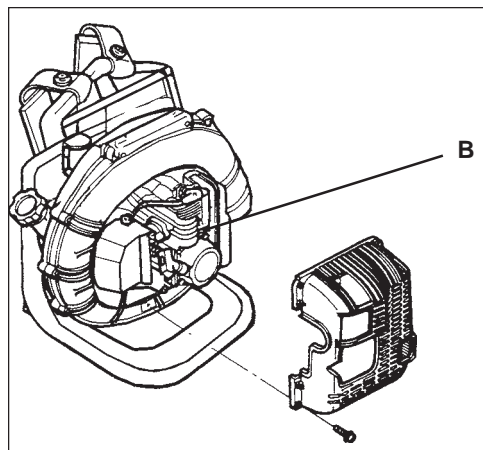

EXHAUST SYSTEM

Spark Arrestor Screen

Level 2.

Tools required: Cross head screwdriver, soft metal brush

Parts Required: Spark arrestor screen P/N 14586206720,
(1) Gasket P/N 14586604261

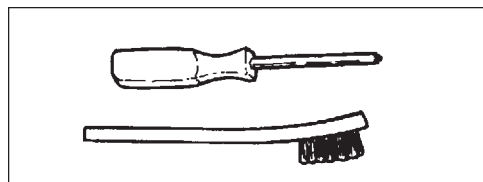

IMPORTANT

Carbon deposits in muffler will cause a drop in engine output and overheating. Spark arrestor screen must be checked periodically.

1. Remove spark plug and engine cover (five screws).
2. Remove spark arrestor cover (A), gasket (B) and spark arrestor screen (C) from muffler.
3. Clean carbon deposits from muffler components.
4. Replace screen if it is cracked, plugged, or has holes burned through.
5. Assemble components in reverse order.

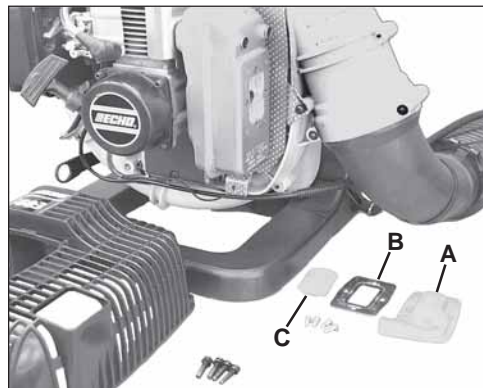

Cylinder Exhaust Port

Level 3.

IMPORTANT

The cylinder exhaust port must be inspected and cleaned of excess carbon every 3 months or 90 hours of operation in order to maintain this engine within the emissions durability period. ECHO strongly recommends that you return your unit to your ECHO dealer for this important maintenance service.

CARBURETOR ADJUSTMENT

Engine Break-In

New engines must be operated for a minimum duration of two tanks of fuel before carburetor adjustments can be made. During the break-in period your engine performance will increase and exhaust emissions will stabilize. Idle speed can be adjusted as required.

High Altitude Adjustment

High altitude adjustment may be required for proper operation of this engine.

IMPORTANT

For engine operation above 2,000 feet, turn the high-speed needle lean (CW) until the engine runs between 7,000 and 8,000 RPM. Then turn the low-speed needle lean (CW) until the engine does not hesitate on acceleration.

For engine operation below 2,000 feet, turn the high-speed needle rich (CCW) until the engine runs between 7,000 and 8,000 RPM. Then turn the low-speed needle rich (CCW) until the engine does not hesitate on acceleration.

DONOTREMOVELIMITERCAPS!

Level 2.

Tools required: Screwdriver, tachometer (Echo P/N 99051130017)

Parts required: None.

NOTE

Do not adjust carburetor unless necessary. If you have difficulty, see your ECHO dealer.

Adjustment Screws

- | | |
|---------------------|-------------------------------------------------------------------------------------------------------------|
| Idle Speed (A) | Control throttle opening at idle. |
| Low (LO) Speed (B) | Controls amount of fuel at low speed and supplementary fuel for smooth progression from idle to high speed. |
| High (HI) Speed (C) | Controls amount of fuel at full throttle |

Before Adjustment

Check that:

- Air filter is clean and properly installed.
- Spark arrestor screen and muffler are free of carbon.
- Blower pipes are installed.

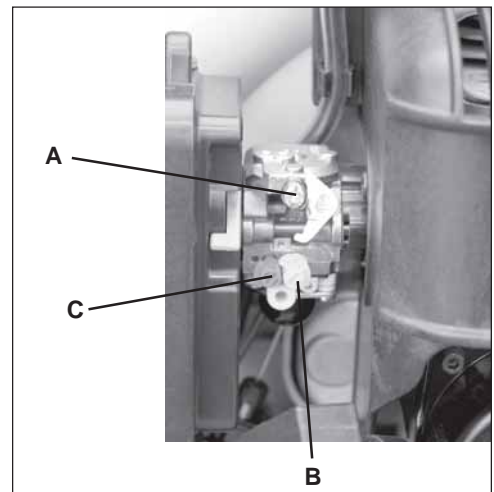
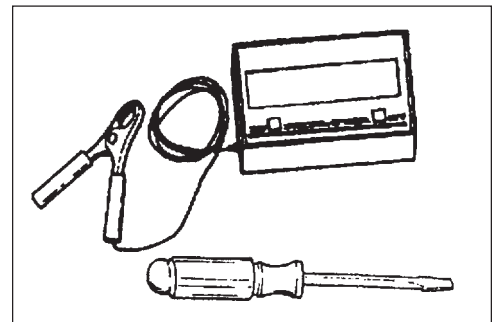

Initial Adjustment

1. With engine off, turn HI speed screw (C) counterclockwise to stop.
2. Turn LO speed screw (B) midway between stops.
3. Turn idle screw (A) until tip of screw just touches throttle plate; then turn three (3) turns clockwise.

Final Adjustment

IMPORTANT

Limiter caps prevent exceeding C.A.R.B. and E.P.A. emission limits and over-rich adjustment, but **not** over lean adjustment, which can cause engine failure: Do not exceed recommended HI speed engine R.P.M. during operation, or for long periods during adjustment.

1. Start engine, run at idle for one minute.
2. Complete warm-up by running at full throttle for 5 minutes, operating choke twice to clear air from carburetor chambers.
3. Run at idle and accelerate to check for smooth transition from idle to high speed; if engine hesitates, turn LO speed screw (B) counterclockwise 1/8th of a turn at a time until acceleration is smooth.
4. Use a tachometer to adjust idle speed to specifications found on page 9.

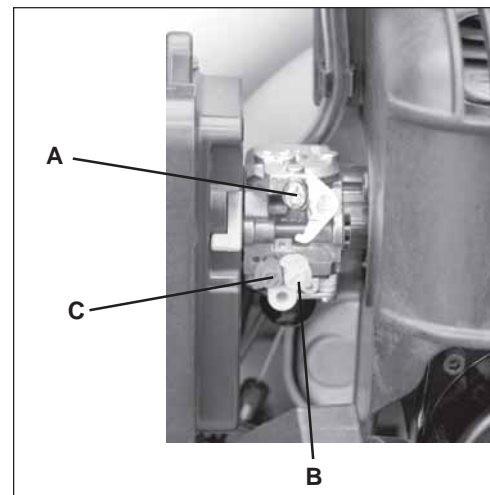

TROUBLESHOOTING

TROUBLESHOOTING CHART

Problem	Check	Status	Cause	Remedy
Engine cranks - starts hard/ doesn't start	Fuel at carburetor	No fuel at carburetor	Fuel strainer clogged Fuel line clogged Carburetor	Clean or replace Clean or replace See your Echo dealer
	Fuel at cylinder	No fuel at cylinder	Carburetor	See your Echo dealer
		Muffler wet with fuel	Fuel Mixture too rich	Open choke Clean/replace air filter Adjust carburetor See your Echo dealer
	Spark at end of plug wire	No spark	Stop switch off Electrical problem Interlock switch	Turn switch to ON See your Echo dealer See your Echo dealer
	Spark at plug	No spark	Spark gap incorrect Covered with carbon Fouled with fuel Plug defective	Adjust to .65mm (0.026 in.) Clean or replace Clean or replace Replace plug
Engine runs, but dies or does not accelerate properly	Air filter	Air filter dirty	Normal wear	Clean or replace
	Fuel filter	Fuel filter dirty	Contaminants/residues in fuel	Replace
	Fuel vent	Fuel vent plugged	Contaminants/residues in fuel	Clean or replace
	Spark Plug	Plug dirty/worn	Normal wear	Clean and adjust or replace
	Carburetor	Improper adjustment	Vibration	Adjust
	Cooling System	Cooling system dirty/plugged	Extended operation in dirty/dusty locations	Clean
	Spark Arrestor Screen	Spark arrestor screen plugged	Normal wear	Replace
Engine does not crank	N/A	N/A	Internal engine problem	See your Echo dealer
Engine runs, blower doesn't work or is weak/uneven	Blower pipe	Pipe clogged	Build-up of debris	Unclog
		Pipe loose	Vibration	Tighten
		Pipe damaged	Wear/Misuse	Replace

WARNING



DANGER

Fuel vapors are **extremely** flammable and may cause fire and/or explosion. **Never** test for ignition spark near an open spark plug opening, otherwise serious personal injury may result.

STORAGE

WARNING DANGER

During operation the muffler or catalytic muffler and surrounding cover become hot. Always keep exhaust area clear of flammable debris during transportation or when storing, otherwise serious property damage or personal injury may result.

Long Term Storage (Over 30 Days)

Do not store your unit for a prolonged period of time (30 days or longer) without performing protective storage maintenance which includes the following:

1. Store unit in a dry, dust-free place, out of the reach of children.

WARNING DANGER

Do not store in enclosure where fuel fumes may accumulate or reach an open flame or spark.

2. Place the stop switch in the "STOP" position.
3. Remove accumulation of grease, oil, dirt and debris from exterior of unit.
4. Perform all periodic lubrication and services that are required.
5. Tighten all screws and nuts.
6. **Drain** the fuel tank **completely** and pull the recoil starter handle several times to remove fuel from the carburetor.
7. Remove the spark plug and pour 7cc (1/4 oz.) of fresh, clean ECHO 2-stroke engine oil into the cylinder through the spark plug hole.
 - A. Place a clean cloth over the spark plug hole.
 - B. Pull the recoil starter handle 2-3 times to distribute the oil inside the engine.
 - C. Observe the piston location through the spark plug hole. Pull the recoil handle slowly until the piston reaches the top of its travel and leave it there.
8. Install the spark plug (do not connect ignition cable).
9. Remove blower pipe assembly from unit.

NOTES

SERVICING INFORMATION

PARTS

Genuine ECHO Parts and ECHO REPOWER™ Parts and Assemblies for your ECHO products are available only from an Authorized ECHO Dealer. When you do need to buy parts, **always** have the Model Number and Serial Number of the unit with you. You can find these numbers on the engine housing. For future reference, write them in the space provided below.

Model No. _____ SN. _____

SERVICE

Service of this product during the warranty period must be performed by an Authorized ECHO Service Dealer. For the name and address of the Authorized ECHO Service Dealer nearest you, ask your retailer or call: 1-800-432-ECHO (3246). Dealer information is also available on our Web Site. When presenting your unit for warranty service/repairs, proof of purchase is required.

ECHO CONSUMER PRODUCT SUPPORT

If you require assistance or have questions concerning the application, operation, or maintenance of this product, you may call the ECHO Consumer Product Support Department at 1-800-673-1558 from 8:30 am to 4:30 pm (Central Standard Time) Monday through Friday. Before calling, please know the model and serial number of your unit to help your Consumer Product Support Representative.

WARRANTY REGISTRATION

You may register your Echo equipment using the warranty registration card, or register on-line at www.echo-usa.com. Registering provides a direct link between you and ECHO if we find it necessary to contact you.

ADDITIONAL OR REPLACEMENT MANUALS

Safety Manuals in English/Spanish or English/French are available, free of charge, from your ECHO dealer or at www.echo-usa.com.

Operator's and Parts Manuals are available by:

- Downloading free from www.echo-usa.com
- Purchasing from your Echo Dealer.
- Sending a check or money order for \$2.00 per Parts Catalog, or \$1.50 per Operator's Manual, made payable to ECHO, INCORPORATED. State on a sheet of paper the model number and serial number of the ECHO unit you have, part number of the manual (if known), your name and address, and mail to address below.

Safety Videos are available from your Echo dealer. A \$5.00 shipping charge will be required for each video.

Available Parts Catalog

PB-603

Serial Number 001001 - 03001000

Part Number 99922203372



DEALER?

Call
1-800-432-ECHO
or
www.echo-usa.com

CONSUMER PRODUCT SUPPORT

1-800-673-1558
8:30 - 4:30 Mon - Fri C.S.T.



ECHO
ECHO, INCORPORATED
400 OAKWOOD ROAD
LAKE ZURICH, IL 60047
www.echo-usa.com