



# 99944200620

## ProPaddle™ Attachment

**FOR MODELS: SRM-2400SB, 260SB, 261SB, PAS-2400, 2601, 230, 231, 260, 261, 265, 266, 280, 2620**

# *Operator's Manual*

### **WARNING**



*Users of this equipment risk injury to themselves and others if the unit is used improperly and/or safety precautions are not followed. ECHO provides an operator's manual. It must be read and understood for proper and safe operation. Failure to do so could result in serious injury.*

Specifications, descriptions and illustrative material in this literature are as accurate as known at the time of publication, but are subject to change without notice. Illustrations may include optional equipment and accessories, and may not include all standard equipment.

---

**TABLE OF CONTENTS**

---

Introduction ..... 3  
    The Operator's Manual ..... 3  
Servicing Information ..... 3  
    Parts/Serial Number ..... 3  
    Service ..... 3  
    Echo Consumer Product Support ..... 4  
    Product Registration ..... 4  
    Additional or Replacement Manuals ..... 4  
Safety ..... 4  
    Manual Safety Symbols and Important Information ..... 4  
    International Symbols ..... 5  
    Personal Condition and Safety Equipment ..... 6  
    Equipment ..... 11  
Description ..... 12  
Contents ..... 13  
Assembly ..... 13  
    ProPaddle Gear Housing to Lower Drive Shaft Assembly ..... 13  
    ProPaddle Sweeper Drum Assembly ..... 14  
    Power Head Shaft/Lower Shaft Assembly ..... 15  
Operation ..... 17  
    Break-In ..... 17  
    Sweeping Operation ..... 17  
Maintenance ..... 19  
    Skill Levels ..... 19  
    Maintenance Intervals ..... 20  
    Lubrication ..... 20  
    Gear Case ..... 22  
Storage ..... 23  
    Storage Hook Installation ..... 24  
Specifications ..... 25  
Product Registration ..... 26

# INTRODUCTION

Welcome to the ECHO family. This ECHO product was designed and manufactured to provide long life and on-the-job dependability. Read and understand this manual. You will find it easy to use and full of helpful operating tips and SAFETY messages.

## The Operator’s Manual

Keep it in a safe place for future reference. Contains specifications and information for safety, operation, maintenance, storage and assembly specific to this product. Scan QR codes throughout the operator’s manual for more information.

# SERVICING INFORMATION

ENGLISH

## Parts/Serial Number

Genuine ECHO Parts and Assemblies for your ECHO products are available only from an Authorized ECHO Dealer. When you do need to buy parts always have the Model Number and Serial Number of the unit with you. For future reference write them in the space provided below.

Model No. \_\_\_\_\_

Serial No. \_\_\_\_\_

## Service

Service of this product during the warranty period must be performed by an Authorized ECHO Service Dealer. For the name and address of the Authorized ECHO Service Dealer nearest you, ask your retailer or call:

1-800-432-ECHO (3246). Dealer information is also available on our Web Site. [www.echo-usa.com](http://www.echo-usa.com). When presenting your unit for Warranty service/repairs, proof of purchase is required.

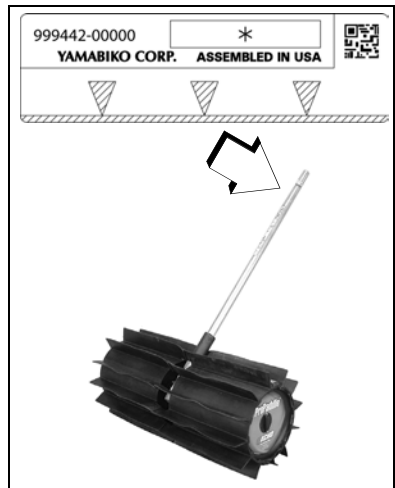

---

## Echo Consumer Product Support

If you require assistance or have questions concerning the application, operation, or maintenance of this product, call the ECHO Consumer Product Support Department at 1-800-673-1558 from 8:00 am to 5:00 pm (Central Standard Time) Monday through Friday. Before calling, please know the model and serial number of your unit.

## Product Registration

Register your ECHO equipment on-line at [www.echo-usa.com](http://www.echo-usa.com) or by filling out the product registration sheet included in this manual. Registering your product confirms warranty coverage and provides a direct link to ECHO if we find it necessary to contact you.

## Additional or Replacement Manuals

**Replacement Operator or Safety Manuals, and Parts Catalogs**, are available from your Authorized ECHO Service Dealer, or at [www.echo-usa.com](http://www.echo-usa.com), or by contacting ECHO Inc., 400 Oakwood Road, Lake Zurich, IL 60047 (800-673-1558). Always check [www.echo-usa.com](http://www.echo-usa.com) for updated information.



**Safety Videos** are available from your Authorized ECHO Service Dealer. A \$5.00 shipping charge is required for each video.

---

## SAFETY

### Manual Safety Symbols and Important Information

Throughout this manual and on the product itself, you will find safety alerts and helpful, informational messages preceded by symbols or key words. The following is an explanation of those symbols and key words and what they mean to you.

## DANGER

*The safety alert symbol accompanied by the word “DANGER” calls attention to an act or condition which WILL lead to serious personal injury or death if not avoided.*

**! WARNING**

The safety alert symbol accompanied by the word “WARNING” calls attention to an act or condition which CAN lead to serious personal injury or death if not avoided.

**! CAUTION**

The safety alert symbol accompanied by the word “CAUTION” calls attention to an act or condition which may lead to minor or moderate personal injury if not avoided.

**NOTICE**

The enclosed message provides information necessary for the protection of the unit.

Note: This enclosed message provides tips for use, care and maintenance of the unit.











**CIRCLE AND SLASH SYMBOL**

This symbol means the specific action shown is prohibited. Ignoring these prohibitions can result in serious or fatal injury.

**International Symbols**

Symbol	Description	Symbol	Description
	Warning, see Operator’s Manual.		Safety/Alert
	Wear eye, ear and head protection.		Finger Severing
	Wear hand and foot protection.		Rotating Cutting Attachment
	Wear face shield.		Wear slip resistant foot wear.

Symbol	Description	Symbol	Description
	Keep feet away from blade.		Do not operate closer than 15 m (50 ft.) from electrical hazards. Keep bystanders at least 15 m (50 ft.) away.
	DO NOT USE BLADES - Line Head Only		Thrown Objects
	Plan retreat path from falling objects.		Hot Surface
		<p><b>AVOID KICKOUT</b> Keep bystanders at least 15 m (50 ft.) away.</p> <p>Beware of thrown objects, wear eye protection.</p>	
		<p>Keep bystanders and helpers at least 15 m (50 ft.) away.</p>	

**Personal Condition and Safety Equipment**

** WARNING**

*Users of this product risk injury to themselves and others if the unit is used improperly and/or safety precautions are not followed. Proper clothing and safety gear must be worn when operating unit.*

**Physical Condition**

Your judgment and physical dexterity may not be good:

- If you are tired or sick.
- If you are taking medication.

- If you have taken alcohol or drugs.

Operate unit only if you are physically and mentally well.

### Eye Protection

## WARNING

- ◆ **Eye protection that meets ANSI Z87.1 or CE requirements must be worn whenever you operate the unit.**
- ◆ **For additional safety, a full-face shield may be worn over safety glasses or goggles to provide protection from sharp branches or flying debris.**

### Hand Protection

Wear sturdy, no-slip, rubber work gloves to improve your grip on the handles. Gloves also provide protection against cuts and scratches, cold environments, and reduce the transmission of machine vibration to your hands.

### Hearing/Ear Protection

ECHO recommends wearing hearing protection whenever unit is used.

### Breathing Protection

Operators who are sensitive to dust or other common airborne allergens may need to wear a dust mask to prevent inhaling these materials while operating unit. Dust masks can provide protection against dust, plant debris, and other plant matter such as pollen. Make sure the mask does not impair your vision, and replace the mask as needed to prevent air restrictions.

### Proper Clothing

Wear snug-fitting, durable clothing:

- Pants should have long legs, shirts should have long sleeves.
- DO NOT WEAR SHORTS.
- DO NOT WEAR TIES, SCARVES, JEWELRY, or clothing with loose or hanging items that could become entangled in moving parts or surrounding growth.
- Keep clothing buttoned or zipped, and keep shirt tails tucked in.

Wear sturdy work shoes with nonskid rubber soles:

- DO NOT WEAR OPEN TOED SHOES.

- DO NOT OPERATE UNIT BAREFOOTED.

Keep long hair away from engine and air intake. Retain hair with cap or net.

Heavy protective clothing can increase operator fatigue, which may lead to heat stroke. Schedule heavy work for early morning or late afternoon hours when temperatures are cooler.

## WARNING

***The components of this machine generate an electromagnetic field during operation, which may interfere with some pacemakers. To reduce the risk of serious or fatal injury, persons with pacemakers should consult with their physician and the pacemaker manufacturer before operating this machine. In the absence of such information, ECHO does not recommend the use of this machine by anyone who has a pacemaker.***

### Extended Operation / Extreme Conditions

## CAUTION

***Prolonged exposure to cold and/or vibration may result in injury. Read and follow all safety and operation instructions to minimize risk of injury. Failure to follow instructions may result in painful wrist/hand/arm injuries.***

It is believed that a condition called Raynaud's Phenomenon, which affects the fingers of certain individuals, may be brought about by exposure to vibration and cold. Exposure to vibration and cold may cause tingling and burning sensations, followed by loss of color and numbness in the fingers. The following precautions are strongly recommended, because the minimum exposure, which might trigger the ailment, is unknown.



- Keep your body warm, especially the head, neck, feet, ankles, hands, and wrists.
- Maintain good blood circulation by performing vigorous arm exercises during frequent work breaks, and also by not smoking.
- Limit the hours of operation. Try to fill each day with jobs where operating the unit or other hand-held power equipment is not required.
- If you experience discomfort, redness, and swelling of the fingers followed by whitening and loss of feeling, consult your physician before further exposing yourself to cold and vibration.

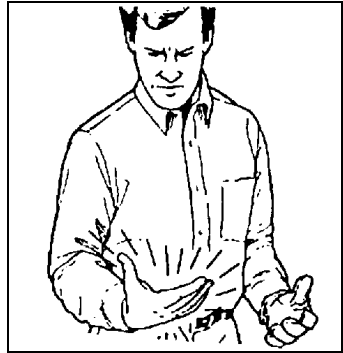

### Repetitive Stress Injuries (RSI)

It is believed that overusing the muscles and tendons of the fingers, hands, arms, and shoulders may cause soreness, swelling, numbness, weakness, and extreme pain in those areas. Certain repetitive hand activities may put you at a high risk for developing a Repetitive Stress Injury (RSI). An extreme RSI condition is Carpal Tunnel Syndrome (CTS), which could occur when your wrist swells and squeezes a vital nerve that runs through the area. Some believe that prolonged exposure to vibration may contribute to CTS. CTS can cause severe pain for months or even years.

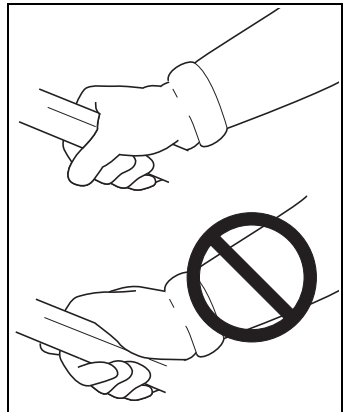

To reduce the risk of RSI/CTS, do the following:

- Avoid using your wrist in a bent, extended, or twisted position. Instead try to maintain a straight wrist position. Also, when grasping, use your whole hand, not just the thumb and index finger.
- Take periodic breaks to minimize repetition and rest your hands.
- Reduce the speed and force with which you do the repetitive movement.
- Do exercises to strengthen the hand and arm muscles.

- Immediately stop using all power equipment and consult a doctor if you feel tingling, numbness, or pain in the fingers, hands, wrists, or arms. The sooner RSI/CTS is diagnosed, the more likely permanent nerve and muscle damage can be prevented.

## DANGER

***All over head electrical conductors and communications wires can have electricity flow with high voltages. This unit is not insulated against electrical current. Never touch wires directly or indirectly, otherwise serious injury or death may result.***

## DANGER

***Do not operate this product indoors or in inadequately ventilated areas. Engine exhaust contains poisonous emissions and can cause serious injury or death.***

### Read the Manuals

- Provide all users of this equipment with the Operator's Manual and Safety Manual for instructions on Safe Operation.

### Clear the Work Area

- Spectators and fellow workers must be warned, and children and animals prevented from coming nearer than 15 m (50 ft.) while the unit is in use.

### Keep a Firm Grip

- Always hold throttle handle and support handle with thumbs and fingers tightly encircling the handles.

### Keep a Solid Stance

- Maintain footing and balance at all times. Do not stand on slippery, uneven or unstable surfaces. Do not work in odd positions or on ladders. Do not over reach.

### Avoid Hot Surfaces

- During operation, the drive shaft housing and attachment bearing housing may become very hot, too hot to touch. Avoid contact during and immediately after operation.



Equipment

 **WARNING**

***Use this attachment with ECHO approved models only. Serious injury may result from the use of this attachment combined with a non approved ECHO product.***

- Check unit for loose/missing nuts, bolts, and screws. Tighten and/or replace as needed.
- Inspect ProPaddle sweeper drums for damage and that they are firmly secured in place. Replace paddles of damaged or worn excessively.
- Check that the ProPaddle attachment is firmly attached and in safe operating condition.

Note: ECHO, INC. will not be responsible for the failure of cutting devices, attachments or accessories which have not been tested and approved by ECHO.

 **WARNING**

***Moving parts can amputate fingers or cause severe injuries. Keep hands, clothing and loose objects away from all openings.***

- ◆ ***ALWAYS stop engine, disconnect spark plug, and make sure all moving parts have come to a complete stop before removing obstructions, clearing debris, or servicing unit.***
- ◆ ***DO NOT start or operate unit unless all guards and protective covers are properly assembled to unit.***
- ◆ ***NEVER reach into any opening while the engine is running. Moving parts may not be visible through openings.***

## DESCRIPTION

Locate the safety decal(s) on your unit. Make sure the decal(s) is legible and that you understand and follow the instructions on it. If a decal cannot be read, a new one can be ordered from your ECHO dealer.

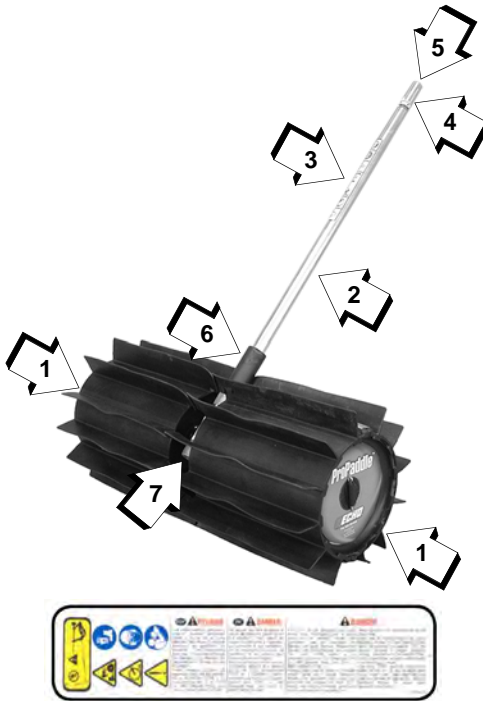

1. **PROPADDLE SWEEPER DRUM ASSEMBLIES** - Replaceable 12-fin rubber paddles provide efficient cleaning action on a wide variety of surfaces. Drums may be switched from side to side to help extend paddle life.
2. **LOWER DRIVE SHAFT ASSEMBLY** - Contains flexible drive cable, outer shaft housing, safety decal, model/serial number/coupling alignment decal, and protective cap for storage.
3. **SAFETY DECAL** - Provides important safety information that must be followed.
4. **MODEL LABEL** - Provides model number and serial number of ProPaddle attachment. Use this information to fill out warranty registration card.

5. FLEXIBLE DRIVE CABLE - Cable end fits into drive shaft coupler of Pro Attachment Series or Split Boom models. Lubricate drive cable every 25 hours of use with Echo Lube or high temperature automotive grease.
6. TUBE PROTECTOR - Reversible rubber sleeve protects lower driveshaft housing from wear.
7. PROPADDLE GEAR HOUSING ASSEMBLY - Sealed gear housing provides maintenance-free operation.

## CONTENTS

The ECHO product you purchased has been factory pre-assembled for your convenience. Due to packaging restrictions, some assembly may be necessary.

After opening the carton, check for damage. Immediately notify your retailer or ECHO Dealer of damaged or missing parts. Use the contents list to check for missing parts.

___1	Gear Housing Assembly
___1	Lower Driveshaft Assembly
___1	Tube Protector
___2	ProPaddle Sweeper Drum Assemblies
___2	Drum Axles
___2	Clevis Pins
___2	Hitch Pins
___2	Split Pins
___1	Operator's Manua
___1	Storage Hook Assembly

## ASSEMBLY

### ProPaddle Gear Housing to Lower Drive Shaft Assembly

Parts Required: ProPaddle Gear Housing Assembly, Lower Drive Shaft Assembly, Tube Protector

1. Remove vinyl cap from lower end of drive shaft tube (end without labels).
2. Remove gear housing shaft alignment screw (B) from right side of gearcase.
3. Loosen gear housing shaft clamp bolt (C).
4. Insert tip of flex shaft (D) into gear housing drive socket.
5. Align hole in drive shaft tube (E) with alignment hole in gear housing (B).

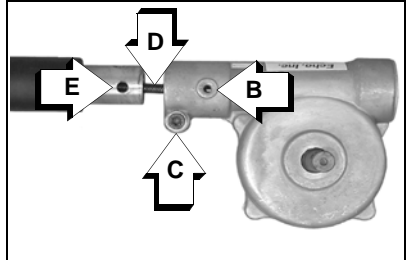

6. Insert lower driveshaft tube (end without model number/ coupling alignment decal) into gear housing shaft mount.
7. Install and tighten alignment screw (B).
8. Tighten gear housing shaft clamp bolt (C).
9. Slide tube protector (A) flush against gearcase housing.

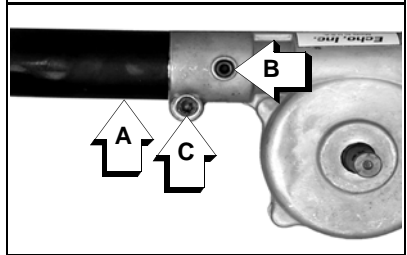

**ProPaddle Sweeper Drum Assembly**

- Parts Required:
- 1 - ProPaddle Gear Housing/Lower Shaft Assembly
  - 2 - ProPaddle Sweeper Drums
  - 2 - Plastic Drum Axles
  - 2 - Clevis Pins
  - 2 - Hitch Pins
  - 2 - Split Pins

1. Slide tapered end of plastic drum axles (E) onto gear housing output shafts.
2. Align mounting holes, and secure drum axles to shafts with clevis pins (F).

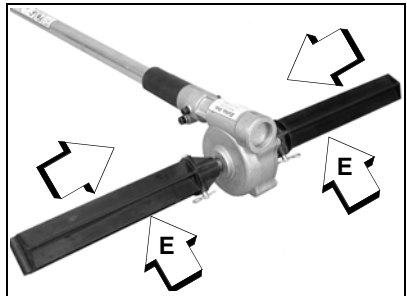

- 3. Insert hitch pins (G) through holes in tip of clevis pins to retain clevis pins.

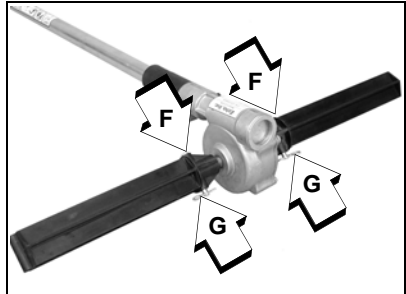

- 4. Slide recessed ends of sweeper drums (H) onto plastic axles, and secure with split pins (I). Spread tips of split pins out to retain pins in axles.

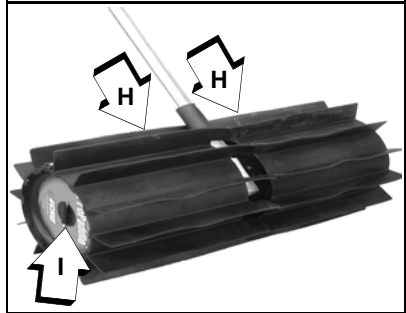

**! CAUTION**

*Thrown objects hazard. Install lower drive shaft to coupler so that gear housing clamping bolt faces downward. Otherwise debris will be thrown toward users.*

**Power Head Shaft/Lower Shaft Assembly**

**! WARNING**

*Do not perform maintenance or assembly procedures with engine running.*

Parts Required: PAS or SRM-SB Power Head w/Shaft & Coupling

- 1. Set Power Head/Shaft Assembly on a level surface.
- 2. Pull locator pin (A) out, and turn counter-clockwise 1/4 turn to lock-out position.
- 3. Remove vinyl cap from attachment drive shaft.
- 4. Remove cardboard spacer, if necessary.



Note: Your coupler may appear different than coupler shown.

- Carefully fit attachment drive shaft assembly into coupler (B) to decal assembly line (C), making sure that the inner lower drive shaft engages the square upper drive shaft socket.

Note: Earlier model Power Heads may have shorter couplings.

Note: Lower bearing housing and head assembly must be in line with the engine.

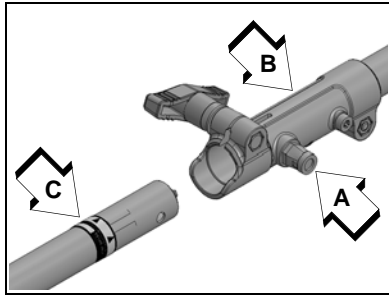

- Rotate locator pin (A) ¼ turn clockwise to engage lower shaft hole. Insure locator pin is fully engaged by twisting lower drive shaft. Locator pin should snap flush in coupler. Full engagement will prevent further shaft rotation.

- Secure lower shaft assembly to coupler by tightening clamping knob (D).

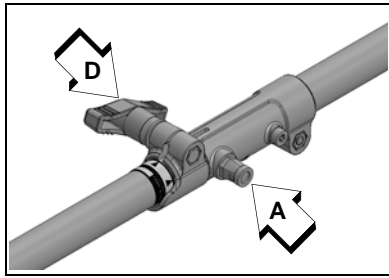



## OPERATION

Note: Refer to your PAS power source Operator's Manuals for correct engine fueling, starting and stopping instructions.

### **WARNING**

***Moving parts can amputate fingers or cause severe injuries. Keep hands, clothing and loose objects away from all openings. Always stop engine, disconnect spark plug, and make sure all moving parts have come to a complete stop before removing obstructions, clearing debris, or servicing unit. Allow unit to cool before performing service.***

### Break-In

1. ProPaddle sweeper drums with new paddle belts must be broken-in before use to prevent the belts from gripping and dragging on hard surfaces.
2. Grip the handles firmly, and position ProPaddle well out in front of your body.
3. Run the ProPaddle at full throttle for 3 - 5 minutes on a rough, abrasive surface such as worn asphalt paving. Allow the ProPaddle's weight to fully rest on the paddle belts.
4. After break-in, the paddle belt fins will slide easily over the surface being cleaned, providing more efficient operation on a variety of surfaces.



### Sweeping Operation

### **WARNING**

***Do not operate ProPaddle with paddles close to your body, which could result in loss of control and possible serious injury.***

1. Hold unit from left side, resting sweeper paddles on work surface.
2. Firmly grasp throttle grip with right hand and front handle with left hand.
3. Position ProPaddle well out in front of your body.
4. Accelerate to full throttle and allow paddles to push debris ahead. Sweep to an area where debris can be piled and collected.



5. Debris may be swept out and away from corners by turning unit over to reverse paddle direction. Grip unit securely using both hands. Operate throttle trigger with thumb of right hand. For extended use, reposition front handle to allow comfortable grip. Return handle to normal position for regular operation.



## **WARNING**

***Turning ProPaddle over to reverse sweeper drum rotation will cause debris to be swept toward operator. Reduce engine speed, and be alert for unstable footing caused by loose debris.***

Note: Extended use of unit at low throttle settings could cause damage to clutch because of clutch slipping.



## MAINTENANCE

### WARNING

***Moving parts can amputate fingers or cause severe injuries. Keep hands, clothing and loose objects away from all openings. Always stop engine, disconnect spark plug, and make sure all moving parts have come to a complete stop before removing obstructions, clearing debris, or servicing unit. Allow unit to cool before performing service. Wear gloves to protect hands from sharp edges and hot surfaces.***

Your ECHO unit is designed to provide many hours of trouble free service. Regular scheduled maintenance will help your unit achieve that goal. If you are unsure or are not equipped with the necessary tools, we recommend that you take your unit to an ECHO Servicing Dealer for maintenance. To help you decide whether you want to DO-IT-YOURSELF or have the ECHO Dealer do it, each maintenance task has been graded. If the task is not listed, see your ECHO Dealer for repairs.

### Skill Levels

**Level 1** = Easy to do. Common tools may be required.

**Level 2** = Moderate difficulty. Some specialized tools may be required.

Click [HERE](#) or go to <http://www.echo-usa.com/products/maintenance-kit> for information on Maintenance Kits.

## Maintenance Intervals

COMPONENT/ SYSTEM	MAINTENANCE PROCEDURE	SKILL LEVEL	INTERVAL
Drive Shaft	Grease	1	Every 25 hours of Use <sup>1</sup>
Gear Case	Lubricate	2	Before Each Use
Paddles	Inspect/Switch/ Replace*	1/2/2	Daily
Tube Protector	Inspect/Rotate/ Reverse/Replace*	1/2/2/2	Weekly
Screws/Nuts/ Bolts	Inspect/Tighten/ Replace	1/1/1	Before Each Use

\*Inspect parts at intervals indicated and service or replace as needed.

**IMPORTANT** - Time intervals shown are maximum. Actual use and your experience will determine the frequency of required maintenance.

<sup>1</sup>Apply lithium based grease.

## Lubrication

### Level 1.

Parts Required: Lithium Base Grease, Mobil SHC634 synthetic gear oil

### Drive Shaft

## NOTICE

*The lower attachment drive shaft must be lubricated with lithium based grease every 25 hours of operation, otherwise drive shaft assembly overheating and failure can result.*

- 1. Remove right ProPaddle sweeper drum assembly and gear housing shaft alignment screw (A).
- 2. Loosen gear housing shaft clamp bolt (B).

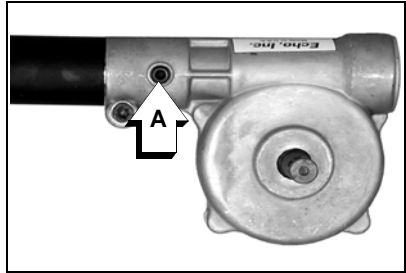

- 3. Remove drive shaft assembly from gear housing.

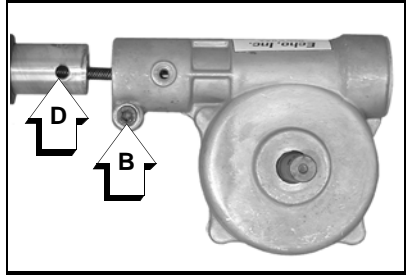

- 4. Pull flexible cable (C) from gear housing end of drive shaft housing, wipe clean, and re-coat with a thin coating [15 ml (1/2 oz.)] of grease.
- 5. Slide the flexible cable back in the drive housing. DO NOT get dirt on the flex cable.
- 6. Insert tip of flex shaft into gear housing drive socket.
- 7. Align hole in gear housing with positioning hole in shaft (D).

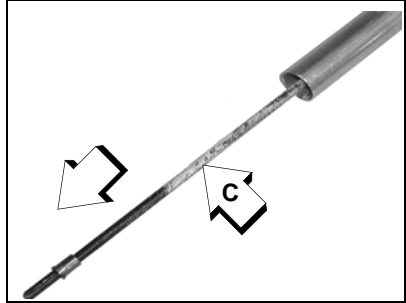

- 8. Insert lower driveshaft tube (end without model number/coupling alignment decal) into gear housing shaft mount.
- 9. Install and tighten alignment screw (A).
- 10. Tighten gear housing shaft clamp bolt (B).
- 11. Make sure tube protector is positioned against gear case housing.

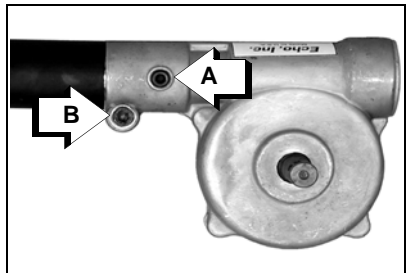

Note: Tube protector may be turned or reversed if worn.

12. Reinstall right ProPaddle sweeper drum assembly and secure with split pin.

## Gear Case

The gearcase should be filled with 60 cc (2.0 fl.oz.) of Mobil SHC634 Synthetic Gear Oil. A maximum of 75-80 cc can be used, but never to exceed 80 cc. Operation with excessive oil level will result in high operating temperatures. Do not overfill when replacing the gearcase oil.

### WARNING

**BURN DANGER!** *The gearcase will be extremely hot after use!*

1. Disconnect spark plug wire at engine.
2. Remove the LH Drum and axle assembly (as viewed from the operating position). Wipe the side-plate clean and remove four screws (it is not necessary to remove the gearcase from the outer tube).
3. Turn gearcase side plate to break the seal and lift the plate from the gearcase.

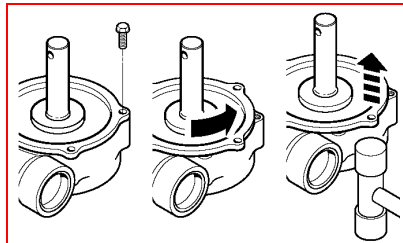

*Turn gearcase side plate to break the seal and lift the plate from the gearcase*

Note: It may be necessary to use a heat gun to soften the sealer material.

4. Turn gearcase side plate to break the seal and lift the plate from the gearcase.
5. Place the gearcase on the RH side and supported so the outer tube is parallel to the ground. Refill the gearcase with 60 cc (2.0 fl.oz) of Mobil SHC634 Synthetic Gear Oil to the bottom of the chamfer on the output gear. The correct oil depth is 5/8 in. (15.5 mm). DO NOT OVERFILL!
6. Inspect the side-plate for damage and clean off all remaining liquid gasket material with brake cleaner or acetone. Coat the outer sealing flange of the side-plate with silicon sealant.

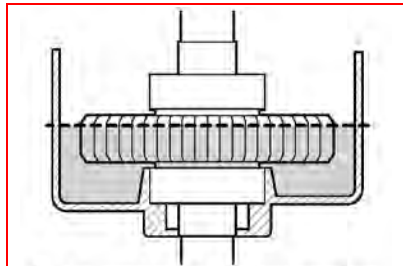

*Fill the gearcase to the bottom of the chamfer on the output gear.  
DO NOT OVERFILL!*

7. Replace the cover and install the four side-plate screws. Tighten securely.
8. Reinstall the drum and axle assembly. Refer to the section “Assembly: Sweeper Assembly” for instructions.

## STORAGE

1. Remove ProPaddle sweeper drum assemblies and drum axles.

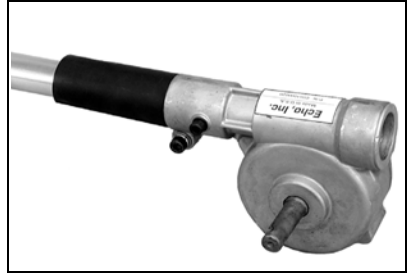

## NOTICE

*Do not immerse the gearcase or driveshaft in water. Water will enter gear housing and damage gears, bearings and seals.*

2. Inspect ProPaddle belts and fins for excessive wear and damage. Have Echo dealer replace paddle belts if fins are worn excessively or distorted, or if belts are damaged.
3. Clean ProPaddle sweeper drums and reusable belts with water.



4. Insert plastic drum axles into drums, and install assembly hardware on axles to avoid loss during storage.
5. Stand drums on outer ends to prevent paddle fins from deforming during storage.
6. Apply a thin coating of oil to gearcase output shafts to prevent rust.
7. Lubricate lower drive shaft with grease. (Refer to Lubrication instructions.)
8. Store ProPaddle components in a cool, dry place. Store gearcase/ lower driveshaft assembly with gearcase down to prevent lubricant leakage from open shaft end.



## NOTICE

*DO NOT allow ProPaddle attachment to rest on paddle fins during prolonged storage, or fins may become flattened.*

### Storage Hook Installation

1. Insert small end of hook into locating hole on attachment shaft.
2. Slide plastic cap onto end of attachment shaft.

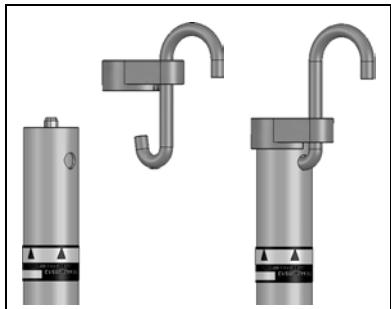



## SPECIFICATIONS

ProPaddle Attachment: Approved for use on PAS and SRM SB models.

MODEL	99944200620
Attachment Length	927.1 mm (36.5 in.)
Attachment Width	571.5 mm (22.5 in.)
Attachment Height	266.7 mm (10.5 in.)
Weight	5.09 kg (11.22 lb.)
Drive shaft	6.35 mm (0.25 in.) flexible shaft
Rotating Direction	Counterclockwise (viewed from operator's right side)
Paddle Diameter	266.7 mm (10.5 in.)
Rubber Fins	Width - 571.5 mm (22.5 in.) Height - 42 mm (1.65 in.)
Lubrication	Drive Shaft - Lithium Base Grease
Gear Reduction Ratio	40:1
Sweeper Rotation Speed	200 RPM
Engine Wide Open Throttle (with attachment)	7700 - 8500 RPM

---

## PRODUCT REGISTRATION

---

### Thank you for choosing ECHO Power Equipment

Please go to <http://www.echo-usa.com/Warranty/Register-Your-ECHO> to register your new product on-line. It's **FAST** and **EASY!** NOTE: your information will never be sold or misused by ECHO, Inc. Registering your purchase enables us to contact you in the unlikely event of a service update or product recall, and verifies your ownership for warranty consideration.

If you do not have access to the Internet, you can complete the form below and mail to:

***ECHO Inc., Product Registration, PO Box 1139, Lake Zurich IL 60047.***



PRODUCT REGISTRATION CARD : TARJETA DE REGISTRO : CARTE D'ENREGISTREMENT DU PRODUIT

**ONLINE OPTION:** Register online and save a stamp! You will be alerted of product updates and/or be sent new ECHO product information and special offers. Simply go to: [www.echo-usa.com](http://www.echo-usa.com)

**OPCIÓN POR INTERNET:** Regístrese en la página web y ahorre una estampilla! Le alertarán sobre actualizaciones del producto y/o se le enviará información sobre los nuevos productos ECHO y ofertas especiales. Simplemente visite: [www.echo-usa.com](http://www.echo-usa.com)

**OPTION EN LIGNE:** Enregistrer en ligne et épargner un timbre! Vous serez informé sur les nouveaux produits ECHO et les mises à jour de produit ainsi que les offres spéciales. Simplement visitez le: [www.echo-usa.com](http://www.echo-usa.com)

Please Print : Por Favor Enscriba Con Letra De Molde : En Lettre Carré S.V.P.

Confidential: Information provided will not be shared or sold

Purchaser's Name : Nombre del Comprador : Nom de l'acheteur	
Address : Dirección : Adresse	
City : Ciudad : Ville	Zip Code - Código Postal : Code Postal
State : Estado : Province	
E-Mail Address : Dirección De Correo Electrónico : Courriel Electronique	
Phone Number : Número De Teléfono : Téléphone	Date of Purchase : Fecha de la Compra : Date de l'achat
Where Purchased : Nombre del Almacén donde fue Comprado : Lieu d'achat	
Model Number : Numero del Modelo : No. de modèle	Serial Number : Numero de Serie : No. de série

Registering your purchase enables us to contact you in the unlikely event of a service update or product recall and verifies your purchase. We will never give your name or address to anyone else without your permission. We reserve the right to cancel this service at any time without notice. Please do not provide this information if you are not the owner of the product. The registration of your purchase will be void if you do not provide the correct information. L'enregistrement de votre achat nous permettra de vous contacter dans le cas improbable de modifications des instructions d'emballage ou de rappel du produit et vérifier que vous êtes le propriétaire en cas de vol ou de perte.

Primary use of tool:  Professional  Homeowner  Rental Equip.  
 Uso primario de la herramienta:  Profesional  Dueño de casa  Alquiler  
 Usage principal:  Professionnel  Résidentiel  Location  
 Do you wish to receive periodic ECHO product information and special offers by e-mail?  Yes  No

¿Desea usted recibir información periódica y ofertas especiales por correo electrónico sobre el producto ECHO?  Yes  No

Souhaitez-vous recevoir périodiquement de l'information sur les produits ECHO et les offres spéciales par courrier électronique?  Oui  Non

Did you visit the ECHO website before purchasing your product?  Yes  No

Visité usted la página web ECHO antes de comprar su producto?  Si  No

Avez-vous visité le site d'ECHO avant de procurer votre produit?  Oui  Non

What factor(s) most influenced your purchase?  
 Performance  Price  Dealer  
 Reliability  Prior Experience  Quality  
 Friend/Family  Brand  Warranty

¿Que factor(es) influenció más en su compra?  
 Funcionamiento  Precio  Distribuidor  
 Confiabilidad  Experiencia Anterior  Calidad  
 Amigo/Familia  Marca  Garantía

Quel facteur (facteurs) vous a influencé le plus?  
 Performance  Prix  Marchand  
 Fiabilité  Expérience  Qualité  
 Ami/Famille  Marque  Garantie

ECHO INC., 400 Oakwood Rd., Lake Zurich, IL 60047  
 1.800.432.ECHO [WWW.ECHO-USA.COM](http://WWW.ECHO-USA.COM)

X7572270206 02-2012

ENGLISH



S09000024500 - S09000999999



**ECHO, INCORPORATED**

400 Oakwood Road  
Lake Zurich, IL 60047

**[www.echo-usa.com](http://www.echo-usa.com)**