



# Power Edger

## *Operator's Manual*

**MODEL PE-200**

**WARNING ! DANGER**



The muffler or catalytic muffler and surrounding cover may become extremely hot.

Always keep clear of exhaust and muffler area, otherwise serious personal injury may occur.



**WARNING !**



The engine exhaust from this product contains chemicals known to the State of California to cause cancer, birth defects or other reproductive harm.



**WARNING ! DANGER**

Read rules for safe operation and instructions carefully. ECHO provides an Operator's Manual and a Safety Manual. Both must be read and understood for proper and safe operation.

## INTRODUCTION

Welcome to the ECHO family. This ECHO product was designed and manufactured to provide long life and on-the-job-dependability. Read and understand this manual and the SAFETY MANUAL you found in the same package. You will find both easy to use and full of helpful operations tips and SAFETY messages.

## THE OPERATOR'S MANUAL

Read and understand this manual before operation. Keep it in a safe place for future reference. Contains specifications and information for operation, starting, stopping, maintenance, storage and assembly specific to this product.

## THE SAFETY MANUAL

Read and understand this manual before operation. Keep it in a safe place for future reference. Explains possible hazards involved with the use of Edgers and the measures you should take to make their use safer.

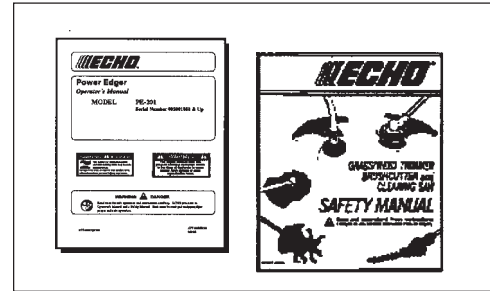

## TABLE OF CONTENTS

Introduction .....	2	- Starting Warm Engine .....	15
- The Operator's Manual .....	2	- Stopping Engine .....	15
- The Safety Manual .....	2	- Operating Techniques .....	16
Manual Safety Symbols and Important Information ..	3	Maintenance .....	17
Safety .....	3	- Skill Levels .....	17
- Decals .....	3	- Maintenance Intervals .....	17
- International Symbols .....	4	- Air Filter .....	18
Safety Instructions .....	4	- Fuel Filter .....	18
- Personal Condition and Safety Equipment .....	4	- Spark Plug .....	19
- Extended Operation/Extreme Conditions .....	5	- Cooling System .....	19
- Equipment .....	5	- Exhaust System .....	20
- Safe Operation .....	6	- Carburetor Adjustment .....	21
Emission Control .....	6	- Lubrication .....	22
Description .....	7	- Blade Replacement .....	23
- Contents .....	7	Troubleshooting .....	24
Specifications .....	10	Storage .....	25
Assembly .....	11	Servicing Information .....	28
- Drive Shaft/Power Head .....	11	- Parts .....	28
- Throttle Linkage .....	11	- Service .....	28
- Front Handle .....	12	- ECHO Consumer Product Support .....	28
Pre-Operation .....	13	- Warranty Card .....	28
- Fuel .....	13	- Additional or Replacement Manuals .....	28
Operation .....	14		
- Starting Cold Engine .....	14		

Specifications, descriptions and illustrative material in this literature are as accurate as known at the time of publication, but are subject to change without notice. Illustrations may include optional equipment and accessories, and may not include all standard equipment.

## MANUAL SAFETY SYMBOLS AND IMPORTANT INFORMATION

Throughout this manual and on the product itself, you will find safety alerts and helpful informational messages preceded by symbols or key words. The following is an explanation of those symbols and key words and what they mean to you.



This symbol accompanied by the words **WARNING** and **DANGER** calls attention to an act or condition that can lead to serious personal injury to operator and bystanders.



The circle with the slash symbol means whatever is shown within the circle is prohibited.



### IMPORTANT

The enclosed message provides information necessary for the protection of the unit.

### NOTE

This enclosed message provides tips for use, care and maintenance of the unit.

## SAFETY DECALS

Locate these safety decals on your unit. Make sure the decals are legible and that you understand and follow the instructions on them. If a decal cannot be read, a new one can be ordered from your ECHO Dealer. See PARTS ORDERING instructions for specific information. These decals are in English only:

### Shaft Decal

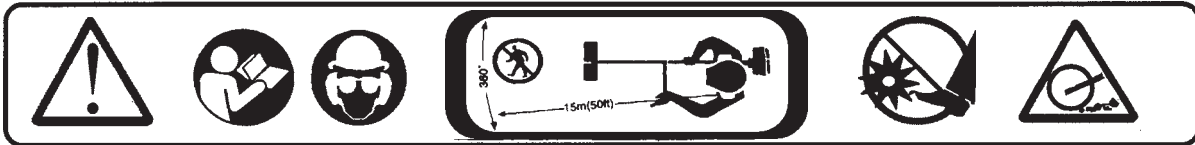

P/N 89016025560

### Hot Decal (near muffler)

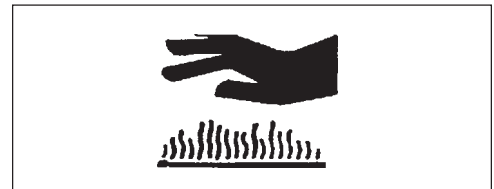

P/N 89016006361

### - WARNING - DANGER - ⚠

- When used improperly this edger could cause serious personal injury. Read and follow all safety precautions in the owner's manual.
- Never operate without eye protection.
- Always inspect area for hidden or throwable objects. Never use in gravel.
- Stay clear of rotating blade at all times. Keep bystanders at least 50' away.
- Stop engine before adjusting cutting height or performing any service.
- Never operate with unit positioned on left side of body.
- Use only ECHO approved replacement blades on this unit.
- Do not use edger blade on any brush cutter.
- Edger attachment and blade are intended for edging only.
- After replacing or servicing blade, arbors, nut and cotter pins must be assembled properly.

P/N 89016052631

P/N 89016052631

## INTERNATIONAL SYMBOLS

Symbol form/ shape	Symbol description/ application	Symbol form/ shape	Symbol description/ application
	Read and understand Operator's Manual.		FUEL AND OIL MIXTURE
	WEAR EYES, EARS AND HEAD PROTECTION		Finger Severing
	HOT SURFACE		WEAR HAND PROTECTION. USE TWO HANDED.
	Safety/Alert		DO NOT SMOKE NEAR FUEL.
	AVOID ALL POWER LINES. THIS UNIT IS NOT INSULATED AGAINST ELECTRICAL CURRENT.		DO NOT ALLOW FLAMES OR SPARKS NEAR FUEL.
	Keep bystanders away 15 m (50 ft.)		

Symbol form/ shape	Symbol description/ application	Symbol form/ shape	Symbol description/ application
	Keep feet away from blade		Direction of blade
	Thrown objects		Emergency stop
	Wear slip resistant foot wear.		Carburetor adjustment - Low speed mixture
	Primer bulb		Ignition ON/OFF
	Carburetor adjustment - High speed mixture		Carburetor adjustment - Idle speed
	CHOKE CONTROL "COLD START" POSITION (CHOKE CLOSED)		CHOKE CONTROL "RUN" POSITION (CHOKE OPEN)

## SAFETY INSTRUCTIONS

### PERSONAL CONDITION AND SAFETY EQUIPMENT

## WARNING DANGER

Edger users risk injury to themselves and others if the edger is used improperly and or safety precautions are not followed. Proper clothing and safety gear must be worn when operating an edger.

### *Physical Condition*

Your judgment and physical dexterity may not be good:

- if you are tired or sick,
- if you are taking medication,
- if you have taken alcohol or drugs.

Operate unit only if you are physically and mentally well.

### *Eye Protection*

Wear eye protection that meets ANSI Z87.1 or CE requirements whenever you operate the unit.

### *Hand Protection*

Wear no-slip, heavy duty work gloves to improve your grip on the edger handles. Gloves also reduce the transmission of machine vibration to your hands.

### *Hearing Protection*

ECHO recommends wearing hearing protection whenever unit is used.

### *Proper Clothing*

Wear snug fitting, durable clothing;

- Pants should have long legs, shirts with long sleeves.
- **DO NOT WEAR SHORTS,**
- **DO NOT WEAR TIES, SCARVES, JEWELRY.**

Wear sturdy work shoes with non-skid soles;

- **DO NOT WEAR OPENTOED SHOES,**
- **DO NOT OPERATE UNIT BAREFOOTED.**

### *Hot Humid Weather*

Heavy protective clothing can increase operator fatigue, which may lead to heat stroke. Schedule heavy work for early morning or late afternoon hours when temperatures are cooler.

## EXTENDED OPERATION/EXTREME CONDITIONS

### *Vibration and Cold*

It is believed that a condition called Raynaud's Phenomenon, which affects the fingers of certain individuals, may be brought about by exposure to vibration and cold. Exposure to vibration and cold may cause tingling and burning sensations, followed by loss of color and numbness in the fingers. The following precautions are strongly recommended, because the minimum exposure which might trigger the ailment is unknown.

- Keep your body warm, especially the head, neck, feet, ankles, hands, and wrists.
- Maintain good blood circulation by performing vigorous arm exercises during frequent work breaks, and also by not smoking.
- Limit the hours of operation. Try to fill each day with jobs where operating the edger or other hand-held power equipment is not required.
- If you experience discomfort, redness, and swelling of the fingers, followed by whitening and loss of feeling, consult your physician before further exposing yourself to cold and vibration.

### *Repetitive Stress Injuries*

It is believed that overusing the muscles and tendons of the fingers, hands, arms, and shoulders may cause soreness, swelling, numbness, weakness, and extreme pain in those areas. Certain repetitive hand activities may put you at a high risk for developing a Repetitive Stress Injury (RSI). An extreme RSI condition is Carpal Tunnel Syndrome (CTS), which could occur when your wrist swells and squeezes a vital nerve that runs through the area. Some believe that prolonged exposure to vibration may contribute to CTS. CTS can cause severe pain for months or even years.

To reduce the risk of RSI/CTS, do the following:

- Avoid using your wrist in a bent, extended, or twisted position. Instead, try to maintain a straight wrist position. Also, when grasping, use your whole hand, not just the thumb and index finger.
- Take periodic breaks to minimize repetition and rest your hands.
- Reduce the speed and force with which you do the repetitive movement.
- Do exercises to strengthen the hand and arm muscles.
- Immediately stop using all power equipment and consult a doctor if you feel tingling, numbness, or pain in the fingers, hands, wrists, or arms. The sooner RSI/CTS is diagnosed, the more likely permanent nerve and muscle damage can be prevented.

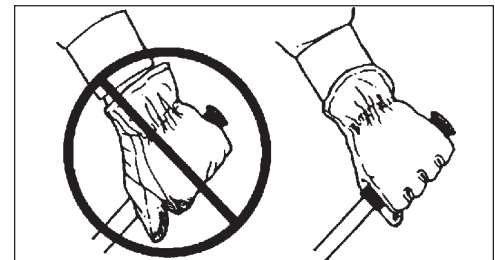

## EQUIPMENT

### **WARNING** **DANGER**

Use only ECHO approved attachments. Serious injury may result from the use of a non approved attachment combination. ECHO, INC. will not be responsible for the failure of cutting devices, attachments or accessories which have not been tested and approved by ECHO. Read and comply with all safety instructions listed in this manual and safety manual.

- Check unit for loose/missing nuts, bolts and screws. Tighten and/or replace as needed.
- Inspect fuel lines, tank, and area around carburetor for fuel leaks. DO NOT operate unit if leaks are found.
- Inspect shield for damage, and that shield is **securely** in place. Replace if shield is damaged or missing.
- Check that the cutting attachment is firmly attached and in safe operating condition.
- Check that front handle is adjusted for safe, comfortable operation. See Assembly for proper adjustment.

## SAFE OPERATION

### WARNING DANGER

Do not operate this product indoors or in inadequately ventilated areas. Engine exhaust contains poisonous emissions and can cause serious injury or death.

#### Read the Manuals

- Provide all users of this equipment with the Operator's Manual and Safety Manual for instructions on Safe Operation.

#### Clear the Work Area

- Spectators and fellow workers must be warned, and children and animals prevented from coming nearer than 15 m (50 ft.) while the unit is in use.

#### Keep a Firm Grip

- Hold the front and rear handles with both hands, with thumbs and fingers encircling the handles.

#### Keep a Solid Stance

- Maintain footing and balance at all times. Do not stand on slippery, uneven or unstable surfaces. Do not work in odd positions or on ladders. Do not over reach.

#### Avoid Hot Surfaces

- Keep exhaust area clear of flammable debris. Avoid contact during and immediately after operation.

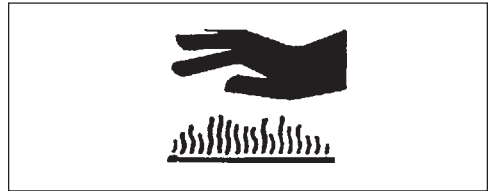

## EMISSION CONTROL

### EPA Phase 2

The emission control system for these engines are EM (Engine Modification).

An Emission Control Label is located on the engine. (This is an EXAMPLE ONLY, information on label varies by engine FAMILY).

#### IMPORTANT ENGINE INFORMATION

ENGINE FAMILY: 4EHXS.0214EF DISPLACEMENT: 21.2 cc  
EMISSION COMPLIANCE PERIOD : 300 HRS.  
THIS ENGINE MEETS U.S. EPA PH 2 EMISSION REGULATIONS FOR SMALL NONROAD ENGINES. REFER TO OWNER'S MANUAL FOR MAINTENANCE SPECIFICATIONS AND ADJUSTMENTS.



**KIORITZ CORP.** 

#### PRODUCT EMISSION DURABILITY

The 300 hour emission durability compliance period is the time span selected by the manufacturer certifying the engine emissions output meets applicable emissions regulations, provided that approved maintenance procedures are followed as listed in the Maintenance Section of this manual.

## DESCRIPTION

The ECHO product you purchased has been partially assembled for your convenience. Due to packaging restrictions, installation of the plastic debris shield, nylon line head, and positioning of the front handle are necessary.

After opening the carton, check for damage. Immediately notify your retailer or ECHO Dealer of damaged or missing parts. Use the contents list to check for missing parts.

\* Some units may be factory pre-assembled. No assembly tools are needed and the parts indicated in the contents list, are pre-assembled to the unit. Only the front handle may need to be re-positioned for comfortable operation.

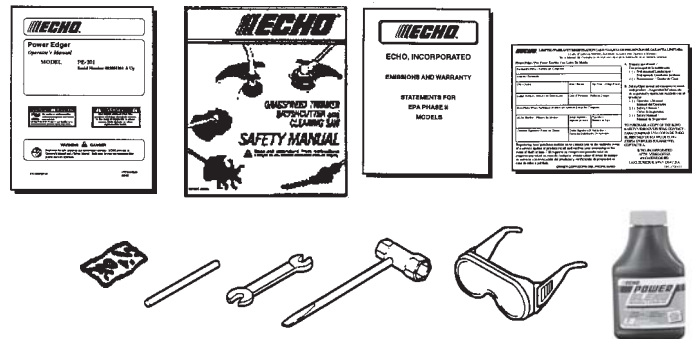

## CONTENTS

- \* \_\_\_ 1, Edger Drive Shaft Assembly
- \* \_\_\_ 1, Power Head
- \_\_\_ 1, Plastic Bag (Co-Pack)
- \_\_\_ 1, Operator's Manual
- \_\_\_ 1, Safety Manual
- \_\_\_ 1, Warranty Registration Card
- \_\_\_ 1, ECHO Emissions and Warranty Statement
- \_\_\_ 1, Echo Power Blend™ 2-stroke oil sample
- \* \_\_\_ 1, Front Handle
- \* \_\_\_ 2, 5x40 mm screws
- \* \_\_\_ 2, 5 mm nuts
- \* \_\_\_ 2, 5 mm washers
- \_\_\_ 1, T-Wrench (Combination Spark Plug Socket/Screwdriver)
- \_\_\_ 2, Split pins
- \_\_\_ 1, Locking Tool
- \* \_\_\_ 1, 8x10 mm Spanner Wrench
- \_\_\_ Safety Glasses

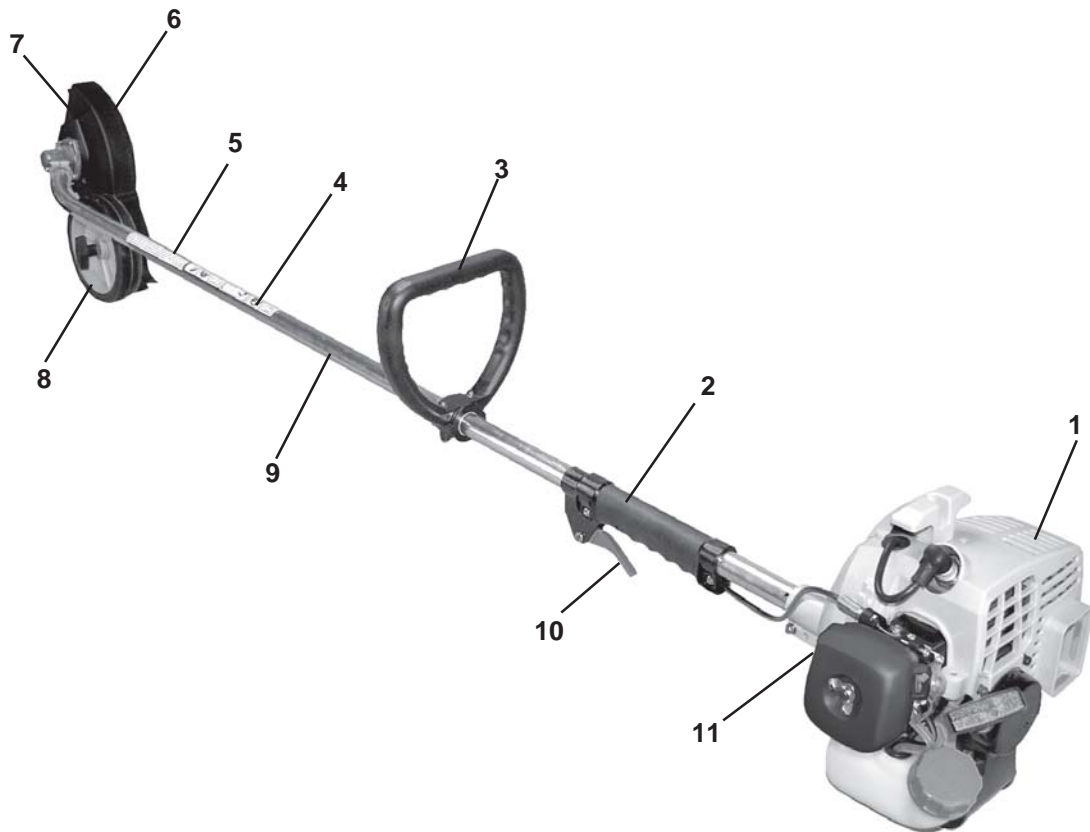
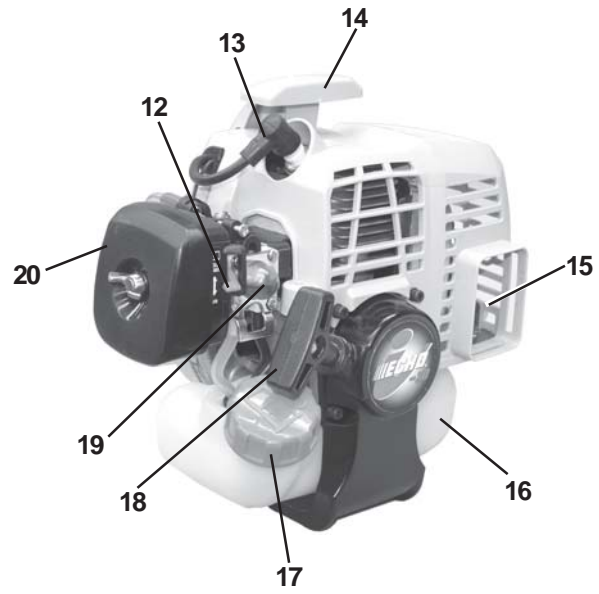





1. **POWER HEAD** - Factory assembled. Includes the engine, clutch, fuel system, ignition system and starter.
2. **GRIP** - Rear (right hand) handle.
3. **FRONT HANDLE** - The front handle can be repositioned for comfortable operation by loosening the screws and moving the handle.
4. **SHAFTDECAL** (See page 3)
5. **SHAFTDECAL** (See page 3)
6. **DEBRIS SHIELD/FLAP** - Mounted over the cutting attachment. Helps protect operator by deflecting debris produced during the edging operation.
7. **BLADE** - Rotates to provide cutting action.
8. **WHEEL** - Adjustable up/down, sets depth of blade.
9. **DRIVE SHAFT ASSEMBLY** - Contains a specially designed liner and the flexible drive shaft.
10. **THROTTLE TRIGGER** - Spring loaded to return to idle when released. When accelerating, press trigger gradually for best operating technique.
11. **STOP SWITCH** - "TOGGLE SWITCH" mounted on the engine. Move switch UP to RUN, DOWN to STOP.
12. **CHOKE** - The choke control is located on the air filter case. Move lever to "COLD START"  to close choke for cold starting. Move lever to "RUN"  position to open choke.
13. **SPARK PLUG** - Provides spark to ignite fuel mixture.
14. **ARM REST** - Protects arm from the hot engine.
15. **SPARK ARRESTOR - CATALYTIC MUFFLER/MUFFLER** - The muffler or catalytic muffler controls exhaust noise and emission. The spark arrestor screen prevents hot, glowing particles of carbon from leaving the muffler. Keep exhaust area clear of flammable debris.
16. **FUEL TANK** - Contains fuel and fuel filter.
17. **FUEL TANK CAP** - Cover and seals fuel tank.
18. **I-30 RECOIL STARTER/HANDLE** - *i30* spring-assisted recoil starter requires 30% less pulling force than standard recoil starter. Pull handle slowly until starter engages, then quickly and firmly. When engine starts, return handle slowly. DO NOT let handle snap back or damage to unit will occur.
19. **PRIMER BULB** - Pumping primer bulb before starting engine draws fresh fuel from the fuel tank priming the carburetor for starting. Pump primer bulb until fuel is visible and flows freely in the clear fuel tank return line. Pump bulb an additional 4 or 5 times.
20. **AIR CLEANER ASSEMBLY** - Contains replaceable felt element.

## SPECIFICATIONS

<b>MODEL</b> .....	<b>PE-200</b>
Length .....	1750mm (68.9 in.)
Width .....	300mm (11.8 in.)
Height .....	290mm (11.4 in.)
Weight (dry w/cutter head) .....	5.38kg (11.9 lb.)
Engine Type .....	Air cooled, two-stroke, single cylinder gasoline engine
Bore .....	32.2 mm (1.27 in.)
Stroke .....	26.0mm (1.02 in.)
Displacement .....	21.2 cc (1.29 cu. in.)
Exhaust .....	Spark Arrestor Muffler
Carburetor .....	Zama diaphragm model w/purge
Ignition System .....	CDI (capacitor discharge ignition)
Spark Plug .....	NGKBPM-8Y 0.65mm (0.026 in.)
Fuel .....	Mixed (Gasoline and Two-stroke Oil)
Fuel/Oil Ratio .....	50:1 two-stroke air cooled engine oil
Gasoline .....	89 Octane unleaded. DO NOT use fuel containing methyl alcohol, more than 10% ethyl alcohol or 15% MTBE.
Oil .....	Power Blend™ Premium Universal 2-Stroke Oil
Fuel Tank Capacity .....	0.45 lit. (15.2 US fl. oz.)
Recoil Starter System .....	<b>i-30</b> Automatic Recoil Starter
Clutch .....	Centrifugal Type
Drive Shaft .....	6.35 mm (1/4 in.) flexible shaft
Rotation Direction .....	Clockwise viewed from right side
Edger Head .....	Metal blade
Blade Length .....	203.2 mm (8.0 in.)
Blade Width .....	50.8 mm (2 in.)
Blade Thickness .....	2.3 mm (0.090 in.)
Handle .....	D-loop, Right - Grip
Vibration Reduction .....	Rubber Cushion
Idle Speed (RPM) .....	2,500-3,300
Wide Open Throttle Speed (RPM) .....	10,000-11,500

## ASSEMBLY

### DRIVE SHAFT/POWER HEAD

*Tools Required:* 8 x 10 mm Spanner Wrench, Cross-Head Screwdriver

*Parts Required:* Power Head, Drive Shaft Assembly

1. Stand engine on a level surface.
2. Loosen the two bolts (A) at drive shaft end of engine.
3. Carefully fit drive shaft assembly to engine, making sure that inner drive shaft engages into clutch mount.

**NOTE**

Rotate the drive shaft housing until edger housing is in line with the engine.

4. Tighten bolts (A).

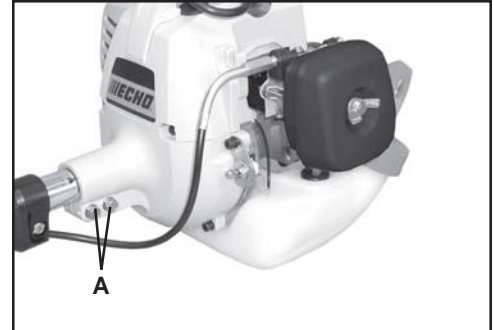

### THROTTLE LINKAGE

1. Manually pivot throttle rotor (B) clockwise until rotor stops, and hold in place.
2. Insert throttle cable (C) through adjustment fixture (D).
3. Align slot in carburetor pivot (E) with throttle cable. Large hole in side of pivot must face away from adjustment fixture.
4. Place cable into slot, and squeeze trigger slowly to seat cable end in large hole. Release throttle rotor and trigger.

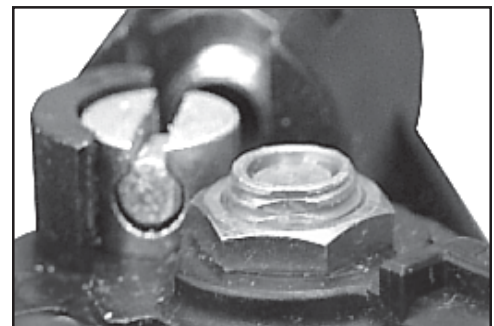
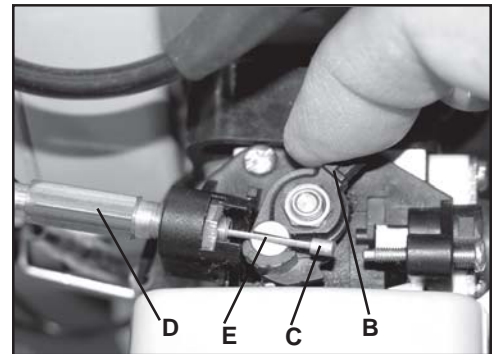

5. Depress trigger, and check for smooth throttle operation:  
IDLE POSITION: Rotor must rest against idle adjustment screw (F) when throttle is released.  
WOT POSITION: Rotor must stop against adjustment fixture (G) when throttle trigger is fully depressed.

**NOTE**

Consult with your Echo Dealer for correct adjustment procedure.

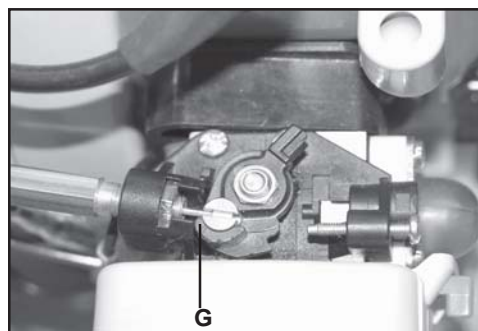
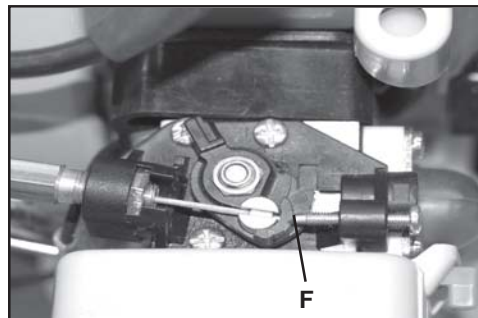

**WARNING**  **DANGER**

Cutting attachment must not move at idle. If attachment moves, see Carburetor Adjustment section page 19.

## FRONT HANDLE

1. Loosely assemble front handle (H) and bracket (I) over collar (J) on drive shaft.
2. Position front handle in comfortable operating position and tighten screws.

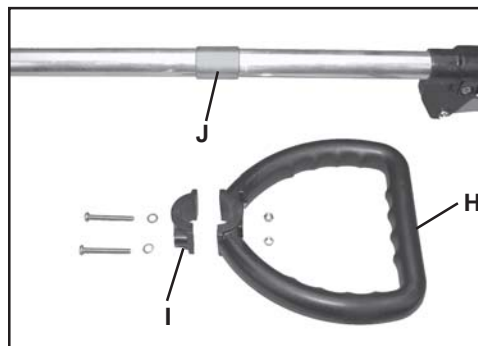

## PRE-OPERATION

### FUEL

#### Fuel Requirements

**Gasoline** - Use 89 Octane [R+M/2] (mid grade or higher) gasoline known to be good quality. Gasoline may contain up to 15% MTBE (methyl tertiary-butyl ether). Gasohol containing methyl (wood) alcohol is **NOT** approved.

**Two Stroke Oil** - A two-stroke engine oil meeting ISO-L-EGD (ISO/CD 13738) and J.A.S.O. FC Standards must be used. Echo brand premium Power Blend™ Universal 2-Stroke Oil meets these standards. Engine problems due to inadequate lubrication caused by failure to use an ISO-L-EGD and J.A.S.O. FC certified oil, such as Echo premium Power Blend™, will void the two-stroke engine warranty. (Emission related parts only are covered for two years, regardless of two-stroke oil used, per the statement listed in the Emission Defect Warranty Explanation.)

#### **IMPORTANT**

Echo premium Power Blend™ Universal 2-Stroke Oil may be mixed at 50:1 ratio for application in all Echo engines sold in the past regardless of ratio specified in those manuals.

#### Mixing Instructions

1. Fill an approved fuel container with half of the required amount of gasoline.
2. Add the proper amount of 2-stroke oil to gasoline.
3. Close container and shake to mix oil with gasoline.
4. Add remaining gasoline and remix.
5. Install fuel container cap and wipe any spilled fuel from container and surrounding area.

#### Handling Fuel

### **WARNING** **DANGER**

Fuel is **VERY** flammable. Use extreme care when mixing, storing or handling, or serious personal injury may result.

- Use an approved fuel container.
- **DO NOT** smoke near fuel.
- **DO NOT** allow flames or sparks near fuel.
- Fuel tanks/cans may be under pressure. Always loosen fuel caps slowly allowing pressure to equalize.
- **NEVER** refuel a unit when the engine is **HOT!**
- **NEVER** refuel a unit with the engine running.
- **DO NOT** fill fuel tanks indoors. **ALWAYS** fill fuel tanks outdoors over bare ground.
- Securely tighten fuel cap after refueling.
- Inspect for fuel leakage. If fuel leakage is found, do not start or operate unit until leakage is repaired.

#### Fuel to Oil Mix - 50:1 Ratio

U.S.		METRIC	
GAS	OIL	GAS	OIL
Gallons	Fl. oz.	Liter	cc.
1	2.6	4	80
2	5.2	8	160
5	13	20	400

#### **IMPORTANT**

Spilled fuel is a leading cause of hydrocarbon emissions. Some states may require the use of automatic fuel shut-off containers to reduce fuel spillage. Contact your ECHO dealer for ordering information.

#### After refueling

- Wipe any spilled fuel from the unit.
- Move at least 3 m (10 ft.) from refueling location before starting the engine.

#### After use

- **DO NOT** store a unit with fuel in its tank. Leaks can occur. Return unused fuel to an approved fuel storage container.

#### Storage

Fuel storage laws vary by locality. Contact your local government for the laws affecting your area. As a precaution, store fuel in an approved, air tight container. Store in a well ventilated, unoccupied building, away from sparks and flames. Do not store fuel longer than 30 days.

#### **IMPORTANT**

Stored fuel ages. Do not mix more fuel than you expect to use in thirty (30) days, ninety (90) days when a fuel stabilizer is added.

#### **IMPORTANT**



Stored two-stroke fuel may separate. **ALWAYS** shake fuel container thoroughly before each use.

## OPERATION

### STARTING COLD ENGINE

#### WARNING DANGER

The attachment will operate immediately when the engine starts and could result in loss of control and possible serious injury. Keep movable parts of the attachment off the ground and away from objects that could become entangled or thrown.

- 1. Stop Switch**  
Move stop switch (A) away from the STOP position.
- 2. Choke**  
Move choke (B) to “Cold Start” () Position.
- 3. Primer**  
Pump primer bulb (C) until fuel will be visible and flows freely in the clear fuel tank return line. Pump bulb an additional 4 or 5 times.
- 4. Recoil Starter**  
Lay the unit on a flat area and keep movable attachment parts clear of all obstacles. Firmly grasp right hand grip with left hand and fully depress throttle trigger to wide open position. Rapidly pull recoil starter handle/rope (D) until engine fires (or maximum five [5] pulls).
- 5. Choke**  
After engine fires or five (5) pulls, move choke lever back to “Run” () position. Hold throttle trigger fully depressed and pull starter handle/rope until engine starts and runs. Release throttle trigger and allow unit to warm up at idle for several minutes.

#### NOTE

If engine does not start with choke in “Run” position after 5 pulls, repeat instructions.

- 6.** After engine warm up, gradually depress throttle trigger to increase engine RPM to operating speed.

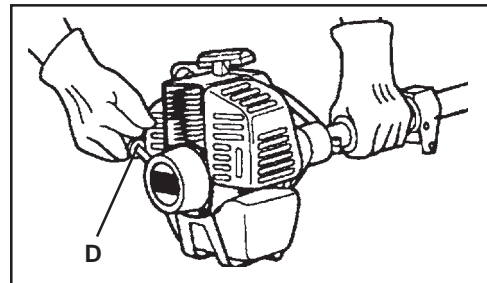
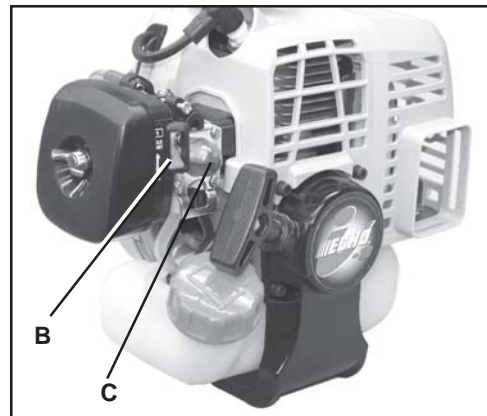
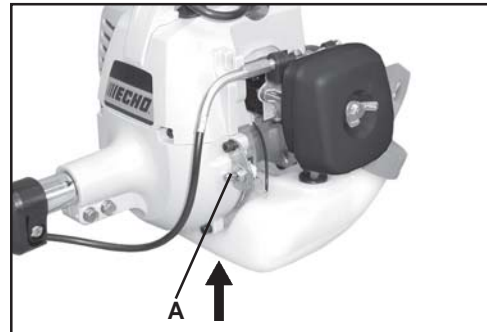

## STARTING WARM ENGINE

The starting procedure is the same as Cold Start except DO NOT close the choke, and do not depress throttle trigger to wide open position.

### **WARNING** **DANGER**

The attachment should not move at idle, otherwise serious personal injury may result.

#### **NOTE**

If attachment moves, readjust carburetor according to "Carburetor Adjustment" instructions in this manual or see your ECHO Dealer.

1. *Stop Switch*  
Move stop switch (A) away from the STOP position
2. *Primer*  
Pump primer bulb (C) until fuel will be visible and flows freely in the clear fuel tank return line. Pump bulb an additional 4 or 5 times.
3. *Recoil Starter*  
Lay the unit on a flat area and keep movable attachment parts clear of all obstacles. Rapidly pull recoil starter handle/rope (D) until engine fires.

#### **NOTE**

If engine does not start after 5 pulls, use Cold Start Procedure.

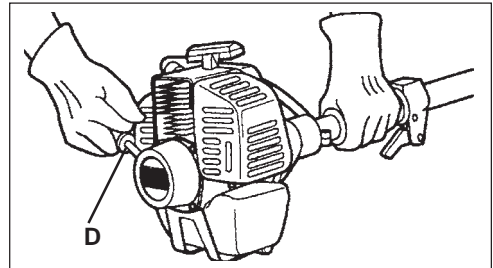
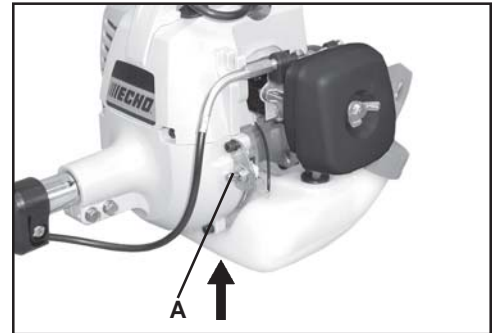

## STOPPING ENGINE

1. *Throttle*  
Release throttle and allow engine to return to idle before shutting off engine.
2. *Stop Switch*  
Move stop switch (A) to STOP position.

### **WARNING** **DANGER**

If engine does not stop when stop switch is moved to STOP position, close choke - COLD START position - to stall engine. Have your ECHO dealer repair stop switch before using edger again.

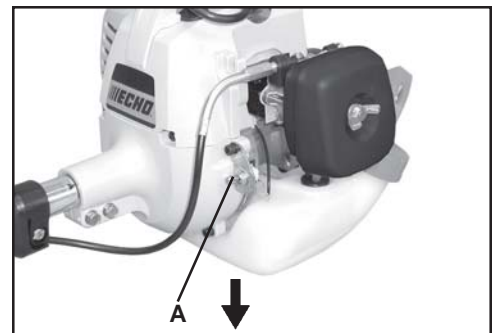

## OPERATING TECHNIQUES

1. Before edging, water the area to soften the ground to make edging easier.
2. Before edging, check the area and remove all obstacles and objects that could be thrown.
3. Plan to edge regularly to make it easier to keep a neat edge and to avoid having to make more than one pass.

### NOTE

Blade depth may have to be adjusted due to differences in height between the hard surface and the top of the grass.



## WARNING DANGER

Never adjust blade height with engine running, otherwise serious personal injury may result.

4. Adjust the blade's depth of cut to produce a fine cut between sidewalk and grass using a minimum blade depth, usually with about 13 mm (1/2 in.) of the blade into the ground.
5. Before edging, plan your direction of travel so that the unit will always be positioned on your right side and so that you walk on a hard surface whenever possible.
6. Hold edger as shown.

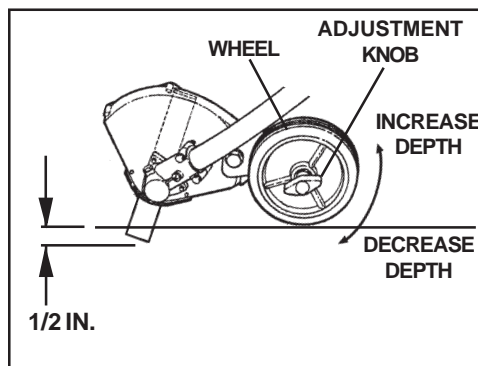

## WARNING DANGER

Before edging, be sure to read and understand the entire Operator's Manual to avoid the chance of serious injury.

7. When starting to edge, run the engine at full throttle, and lower the blade gently into the ground, being careful not to hit the concrete with the blade.
8. Don't force the blade. Move as quickly as the blade will allow.



## WARNING DANGER

The complete unit, specifically the drive shaft assembly and muffler exhaust area may become very hot during use. Avoid contact during and immediately after operation, otherwise serious personal injury may result.

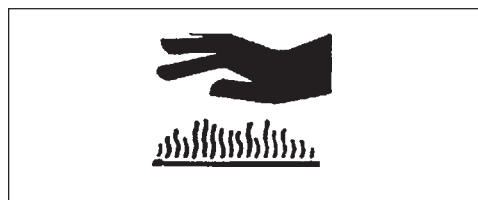



## MAINTENANCE

Your ECHO edger is designed to provide many hours of trouble free service. Regular scheduled maintenance will help your edger achieve that goal. If you are unsure or are not equipped with the necessary tools, you may want to take your unit to an ECHO Service Dealer for maintenance. To help you decide whether you want to DO-IT-YOURSELF or have the ECHO Dealer do it, each maintenance task has been graded. If the task is not listed, see your ECHO Dealer for repairs.

### SKILL LEVELS

- Level 1** = Easy to do. Most required tools come with unit.
- Level 2** = Moderate difficulty. Some specialized tools may be required.
- Level 3** = Experience required. Specialized tools are required. ECHO recommends that the unit be returned to your ECHO dealer for service.

ECHO offers **REPOWER™** Maintenance Kits and Parts to make your maintenance job easier. Just below each task heading are listed the various part numbers required for that task. See your ECHO dealer for these parts.

### MAINTENANCE INTERVALS

COMPONENT/ SYSTEM	MAINTENANCE PROCEDURE	REQ'D SKILL LEVEL	DAILY OR BEFORE USE	EVERY REFUEL	3 MONTHS OR 90 HOURS	6 MONTHS OR 270 HOURS	YEARLY 600 HOURS
<b>Recommended Echo Dealer Maintenance Procedures</b>							
Cylinder Exhaust Port	Inspect/Clean/Decarbon	3			I / C		
<b>Do-It-Yourself Maintenance Procedures</b>							
Air Filter	Inspect/Clean/Replace	1	I / C		R*		
Choke	Inspect/Clean	2	I / C				
Fuel Filter	Inspect/Replace	1			I		R *
Fuel System, leaks	Inspect/Replace	1	I	I / R *			
Cooling System	Inspect/Clean	2	I / C				
Muffler Spark Arrestor	Inspect/Replace	2	I / C		I / R*		
Drive Shaft	Grease	2			I (1)		
Gear Housing	Grease	2			I (2)		
Recoil Starter Rope	Inspect/Clean	1	I / C *				I / R*
Spark Plug	Inspect/Clean	2			I / C	R *	
Blade Replacement	Inspect/Replace	1	I	I	I / R*		
Screws/Nuts/Bolts	Inspect/Tighten/Replace	1	I / R *				

**MAINTENANCE PROCEDURE LETTER CODES: I = INSPECT, R = REPLACE, C = CLEAN**

**IMPORTANT NOTE** - Time intervals shown are maximum. Actual use and your experience will determine the frequency of required maintenance.

**MAINTENANCE PROCEDURE NOTES:**

(1) Apply ECHO® LUBE™ every 50 hours of use.

(2) Apply ECHO® LUBE™ every 15-25 hours of use.

\* All recommendations to replace are based on the finding of damage or wear during inspection..

## AIR FILTER

### Level 1.

*Tools required:* Cleaning brush 25 or 50 mm (1 or 2 in.)

*Parts required:* 90008 REPOWER™ Air & Fuel Filter Kit

1. Close choke (Cold Start Position ). This prevents dirt from entering the carburetor throat when the air filter is removed. Brush accumulated dirt from the air cleaner area.
2. Remove the air cleaner cover. Clean and inspect the element for damage. If element is fuel soaked and very dirty, replace.
3. If element can be cleaned and reused, be certain it:
  - still fits the cavity in the air cleaner cover.
  - is installed with the original side out.



## FUEL FILTER

### Level 1.

*Tools required:* 200-250 mm (8-10 in.) length of wire with one end bent into a hook. Clean rag, funnel, and an approved fuel container

*Parts required:* 90008 REPOWER™ Air & Fuel Filter Kit

### WARNING DANGER

Fuel is **VERY** flammable. Use extreme care when mixing, storing or handling.

1. Use a clean rag to remove loose dirt from around fuel cap and empty fuel tank.
2. Use the “fuel line hook” to pull the fuel line and filter from the tank.
3. Remove the filter from the line and install the new filter.



## SPARK PLUG

### Level 2.

*Tools Required:* T-Wrench, Feeler gauge, Soft metal brush.

*Parts Required:* REPOWER™ Tune-Up Kit P/N 90074

1. Remove spark plug and check for fouling, worn and rounded center electrode.
2. Clean the plug or replace with a new one. DO NOT sand blast to clean. Remaining sand will damage engine.
3. Adjust spark plug gap by bending outer electrode.
4. Tighten spark plug to 145-155 kg/cm (125-135 in. lb.).

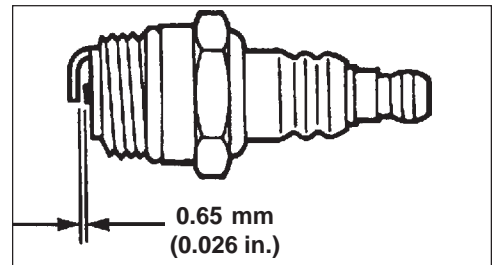
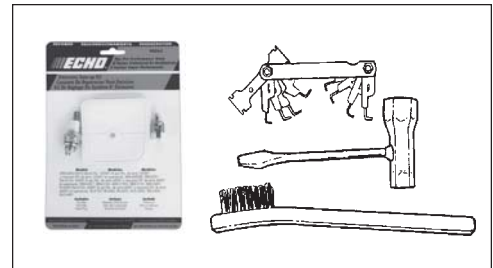

## COOLING SYSTEMS CLEANING

### Level 2.

*Tools required:* Cross Head Screwdriver, 3 mm Hex Wrench, Cleaning Brush 25 or 50 mm (1 or 2 in.)

*Parts Required:* None if you are careful.

#### **IMPORTANT**

To maintain proper engine operating temperatures, cooling air must pass freely through the cylinder fin area. This flow of air carries combustion heat away from the engine.

Overheating and engine seizure can occur when:

- Air intakes are blocked, preventing cooling air from reaching the cylinder.
- Dust and grass build up on the outside of the cylinder. This build up insulates the engine and prevents the heat from leaving.

Removal of cooling passage blockages or cleaning of cooling fins is considered "Normal Maintenance". Any failure attributed to lack of maintenance is not warranted.

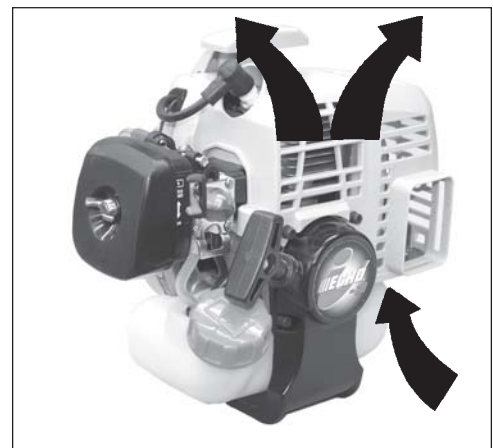
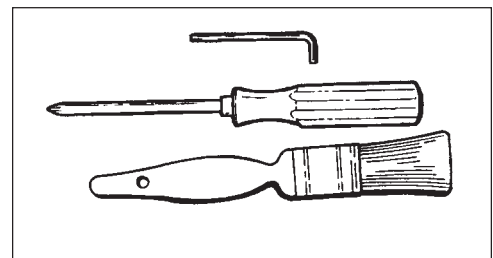

1. Remove spark plug lead from spark plug.
2. Remove muffler cover bolt (A).
3. Remove four screws that retain the engine cover. Two at the top of the Recoil Starter, two on either side of the front. Lift the cover from the engine and lay to the front of the engine.

**NOTE**

The spark plug lead and grommet remain in the engine cover.

**IMPORTANT**

DO NOT use a metal scraper to remove dirt from the cylinder fins.

4. Use the brush to remove dirt from the cylinder fins.
5. Remove grass and leaves from the grid between the recoil starter and fuel tank.
6. Assemble components in reverse order.

**NOTE**

When installing the cover, be certain the tab of the deflector shield is in the slot of the cover.

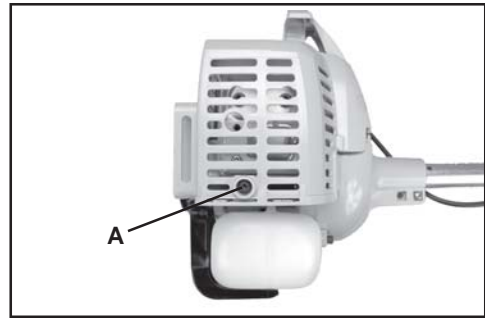

## EXHAUST SYSTEM

### Spark Arrestor Screen

#### Level 2.

*Tools Required:* Cross Head Screwdriver, Soft metal brush.

*Parts Required:* Screen, Gasket

1. Remove engine cover, see "Cooling System Cleaning" for step by step instructions.
2. Remove screen cover (A) and gasket (B) from muffler body.
3. Clean carbon deposits from screen (C) and muffler components.
4. Replace screen if it is cracked, plugged or has holes burned through.

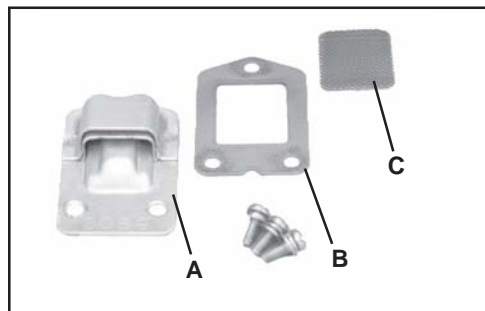
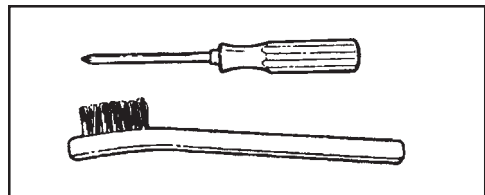

## *Cylinder Exhaust Port*

### Level 3.

#### **IMPORTANT**

The cylinder exhaust port must be inspected and cleaned of excess carbon every 3 months or 90 hours of operation in order to maintain this engine within the emissions durability period. ECHO strongly recommends that you return your unit to your ECHO dealer for this important maintenance service.

## **CARBURETOR ADJUSTMENT**

### *Engine Break-In*

New engines must be operated a minimum duration of two tanks of fuel break-in before carburetor adjustments can be made. During the break-in period your engine performance will increase and exhaust emissions will stabilize. Idle speed can be adjusted as required.

### *High Altitude Adjustment*

High altitude adjustment is not required for proper operation of this engine.

### Level 2.

*Tools required:* Screwdriver, Tachometer (ECHO P/N 99051130017)

*Parts required:* None.

#### **NOTE**

Every unit is run at the factory and the carburetor is set in compliance with emissions regulations. This carburetor does not have acceleration and high speed adjustment needles.

1. Before adjusting the carburetor, clean or replace the air filter and spark arrestor screen.
2. Start engine and run for several minutes to reach operating temperature.
3. Check idle speed and reset if necessary. If a tachometer is available, idle speed screw (A) should be set to the specifications found on page 10 "Specifications" of this manual. Turn idle screw (A) clockwise to increase idle speed; counter clockwise to decrease idle speed.

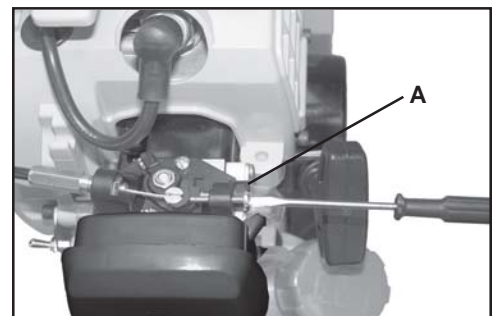
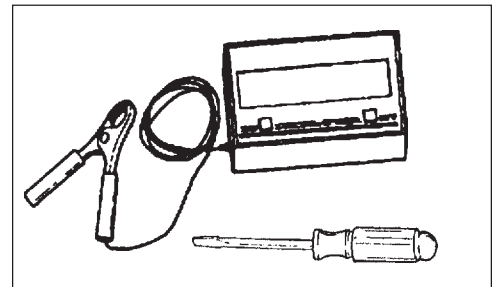

## **WARNING** **DANGER**

When carburetor adjustment is completed, the cutting attachment should not turn at idle, otherwise serious personal injury may result.

## LUBRICATION

### *Gear Housing*

#### Level 1.

*Tools Required:* 13 mm wrench, grease gun P/N 91016, clean rag

*Parts Required:* Echo Lube™ 8 oz. (P/N 91014) or Lithium Base Grease

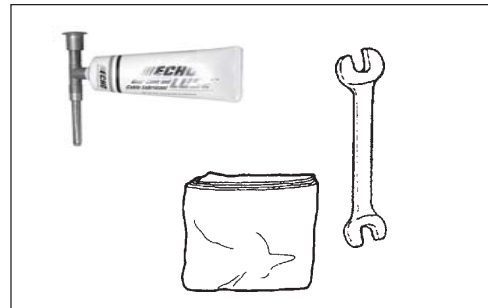

1. Remove plug (A) and grease gear housing. Do not over-fill.
2. Replace plug and tighten securely.



### *Drive Shaft*

#### Level 1.

*Tools required:* 8 mm Open End Wrench, Cross Head Screwdriver, Clean rag

*Parts Required:* ECHO® LUBE™ 8 oz. (P/N 91014) or Lithium Base Grease.

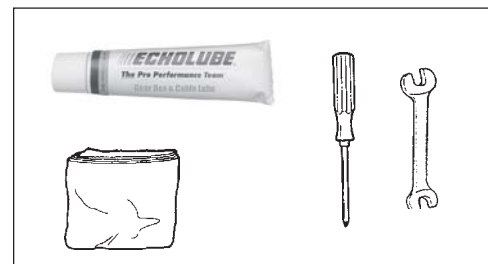

1. Loosen two (2) screws (A) and remove center locating screw (B). Pull gear box and shield from drive shaft housing.
2. Pull flexible cable from the drive shaft housing, wipe clean and recoat with a thin coating [15 ml (1/2 oz.)] of grease.
3. Slide the flexible cable back in the drive housing. DO NOT get dirt on the flex cable.
4. Install the gear housing and shield assembly.
5. Tighten screws securely.

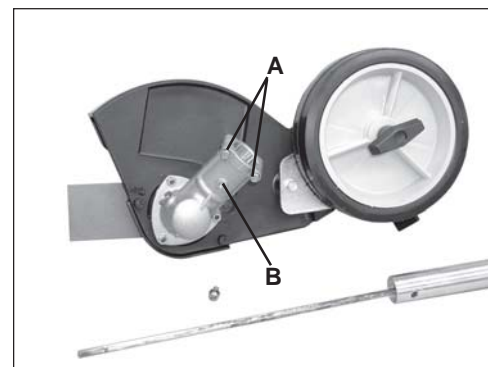

## BLADE REPLACEMENT

### Level 1

*Tools Required:* Locking tool, pliers, T-Wrench

*Parts Required:* Blade P/N 69601553630, new split pin  
P/N 90030020022

#### NOTE

Replace blade when it is worn shorter than 6 inches.

1. Remove split pin (A).
2. Align hole in inner blade adapter (B) with notch in gear housing, and insert locking tool to prevent PTO shaft (C) from rotating.
3. Remove L.H. blade nut (D) by turning clockwise. Remove outer blade adapter (E), and blade (F).
4. Install and center blade (F) on inner blade adapter (B).
5. Install outer adapter (E) and nut (D). Tighten nut (D) firmly, turning counterclockwise.

#### IMPORTANT

Never reuse old split pin.

6. Install new split pin (A) to secure nut, and bend both legs of pin counterclockwise around PTO shaft.

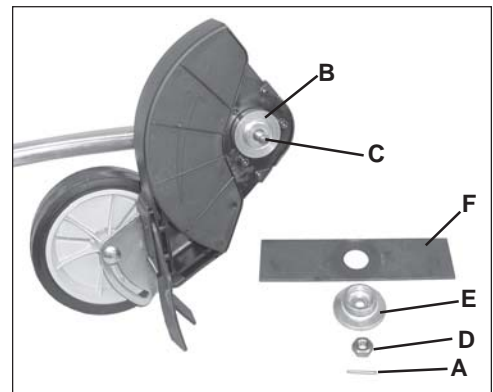
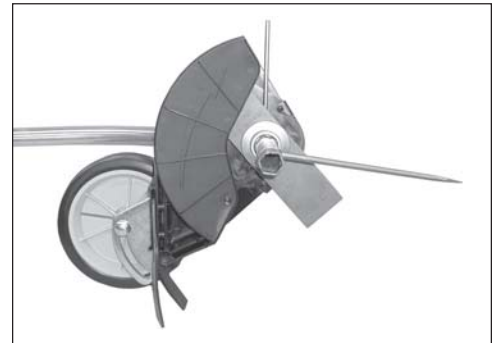
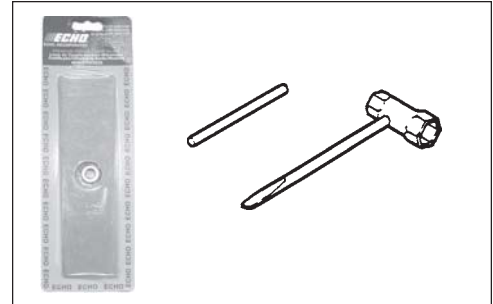

## TROUBLESHOOTING

### ENGINE PROBLEM TROUBLESHOOTING CHART

Problem	Check	Status	Cause	Remedy
Engine cranks - starts hard/ doesn't start	Fuel at carburetor	No fuel at carburetor	Fuel strainer clogged Fuel line clogged Carburetor	Clean or replace Clean or replace See your Echo dealer
	Fuel at cylinder	No fuel at cylinder	Carburetor	See your Echo dealer
		Muffler wet with fuel	Fuel Mixture too rich	Open choke Clean/replace air filter Adjust carburetor See your Echo dealer
	Spark at end of plug wire	No spark	Stop switch off Electrical problem Interlock switch	Turn switch to ON See your Echo dealer See your Echo dealer
	Spark at plug	No spark	Spark gap incorrect Covered with carbon Fouled with fuel Plug defective	Adjust to .65mm (0.026 in.) Clean or replace Clean or replace Replace plug
Engine runs, but dies or does not accelerate properly	Air filter	Air filter dirty	Normal wear	Clean or replace
	Fuel filter	Fuel filter dirty	Contaminants/residues in fuel	Replace
	Fuel vent	Fuel vent plugged	Contaminants/residues in fuel	Clean or replace
	Spark Plug	Plug dirty/worn	Normal wear	Clean and adjust or replace
	Carburetor	Improper adjustment	Vibration	Adjust
	Cooling System	Excessive dirt/debris	Extended operation in dirty/dusty locations	Clean
	Spark Arrestor Screen	Screen cracked, plugged, or perforated	Normal wear	Replace
Engine does not crank	N/A	N/A	Internal engine problem	See your Echo dealer

### WARNING DANGER

Fuel vapors are **extremely** flammable and may cause fire and/or explosion. **Never** test for ignition spark near an open spark plug opening, otherwise serious personal injury may result.



## STORAGE

### WARNING DANGER

During operation the muffler or catalytic muffler and surrounding cover become hot. Always keep exhaust area clear of flammable debris during transportation or when storing, otherwise serious property damage or personal injury may result.

### *Long Term Storage (over 30 days)*

Do not store your unit for a prolonged period of time (30 days or longer) without performing protective storage maintenance which includes the following:

1. Store unit in a dry, dust free place, out of the reach of children.

### WARNING DANGER

Do not store in enclosure where fuel fumes may accumulate or reach an open flame or spark.

2. Place the stop switch in the "STOP" position.
3. Remove accumulation of grease, oil, dirt and debris from exterior of unit.
4. Perform all periodic lubrication and services that are required.
5. Tighten all the screws and nuts.
6. **Drain** the fuel tank **completely** and pull the recoil starter handle several times to remove fuel from the carburetor.
7. Remove the spark plug and pour 7 cc (1/4 oz.) of fresh, clean, two-stroke engine oil into the cylinder through the spark plug hole.
  - A. Place a clean cloth over the spark plug hole.
  - B. Pull the recoil starter handle 2-3 times to distribute the oil inside the engine.
  - C. Observe the piston location through the spark plug hole. Pull the recoil handle slowly until the piston reaches the top of its travel and leave it there.
8. Install the spark plug (do not connect ignition cable).

**NOTES**

**NOTES**

## SERVICING INFORMATION

### PARTS

Genuine ECHO Parts and ECHO REPOWER™ Parts and Assemblies for your ECHO products are available only from an Authorized ECHO Dealer. When you do need to buy parts **always** have the Model Number and Serial Number of the unit with you. You can find these numbers on the engine housing. For future reference, write them in the space provided below.

Model No. \_\_\_\_\_ SN. \_\_\_\_\_

### SERVICE

Service of this product during the warranty period must be performed by an Authorized ECHO Service Dealer. For the name and address of the Authorized ECHO Service Dealer nearest you, ask your retailer or call: 1-800-432-ECHO (3246). Dealer information is also available on our Web Site. When presenting your unit for Warranty service/repairs, proof of purchase is required.

### ECHO CONSUMER PRODUCT SUPPORT

If you require assistance or have questions concerning the application, operation or maintenance of this product you may call the ECHO Consumer Product Support Department at 1-800-673-1558 from 8:30 am to 4:30 pm (Central Standard Time) Monday through Friday. Before calling, please know the model and serial number of your unit to help your Consumer Product Support Representative.

### WARRANTY REGISTRATION

You may register your Echo equipment using the warranty registration card or register on-line at [www.echo-usa.com](http://www.echo-usa.com). Registering provides a direct link between you and ECHO if we find it necessary to contact you.

### ADDITIONAL OR REPLACEMENT MANUALS

**Safety Manuals** in English/Spanish or English/French are available, free of charge, from your ECHO dealer or at [www.echo-usa.com](http://www.echo-usa.com).

**Operator's and Parts Manuals** are available by:

- Downloading free from [www.echo-usa.com](http://www.echo-usa.com)
- Purchasing from your Echo Dealer.
- Manuals are available by sending a written request stating the model number and serial number of your Echo unit, part number of the manual, your name and address, and mail to the address below.

**Safety Videos** are available from your Echo dealer. A \$5.00 shipping charge will be required for each video.



### DEALER?

Call  
**1-800-432-ECHO**  
or  
**[www.echo-usa.com](http://www.echo-usa.com)**

### CONSUMER PRODUCT SUPPORT

**1-800-673-1558**  
**8:30 - 4:30 Mon - Fri C.S.T.**



# **ECHO**®

**ECHO, INCORPORATED**

400 OAKWOOD ROAD  
LAKE ZURICH, IL 60047

**[www.echo-usa.com](http://www.echo-usa.com)**

08001001-08999999