



Operator's Manual DCS-5000 Chainsaw

WARNING

This product contains chemicals known to the State of California to cause cancer, birth defects, or other reproductive harm. Cancer and Reproductive Harm www.P65Warnings.ca.gov

WARNING



Read and understand all provided literature before use. Failure to do so could result in serious injury.

Note: This product complies with CAN ICES-003(B) / NMB-003(B)

9992238004

© 02/2024 ECHO Incorporated

TABLE OF CONTENTS

Introduction.....	3
Servicing Information.....	3
Parts / Serial Number.....	3
Service.....	4
ECHO Consumer Product Support	4
Product Registration.....	4
Additional Literature.....	4
Contents.....	4
Safety.....	5
Manual Safety Symbols and Important Information.....	5
International Symbols.....	6
General Power Tool Safety Warnings.....	7
General Chainsaw Safety Warnings.....	10
FCC Statement.....	13
Environmentally Safe Battery Disposal.....	14
Rules For Safe Operation.....	15
Correct Use of Chain Brake.....	16
Description.....	19
Preparation For Use.....	21
Operation.....	26
Chain Lubricant.....	26
Starting The Unit.....	27
Stopping The Unit.....	27
Checking Chain Tension.....	28
Chain Lubrication Test.....	28
Cutting Instructions.....	28
Maintenance.....	34
Skill Levels.....	34
Maintenance Intervals.....	34
Cleaning Battery And Battery Compartment.....	35
Guide Bar.....	35
Sprocket.....	36
Saw Chain Maintenance.....	36
Troubleshooting.....	39
Storage.....	41
Storage After Use.....	41
Specifications.....	42
Product Registration.....	43
Warranty.....	45

INTRODUCTION

Specifications, descriptions and illustrative material in this literature are as accurate as known at the time of publication, but are subject to change without notice. Illustrations may include optional equipment and accessories, and may not include all standard equipment.



Read and understand all provided literature. Literature contains specifications and information for safety, operation, maintenance, storage, and assembly specific to this product. Scan QR code for more information.



For additional literature, including safety manuals where applicable, or questions regarding terms used in this manual, visit:

<https://www.echo-usa.com/manuals>



SERVICING INFORMATION

Parts / Serial Number

Genuine ECHO Parts and Assemblies for your ECHO products are available only from an Authorized ECHO Dealer. When you do need to buy parts always have the Model Number and Serial Number of the unit with you. For future reference write them in the space provided below.

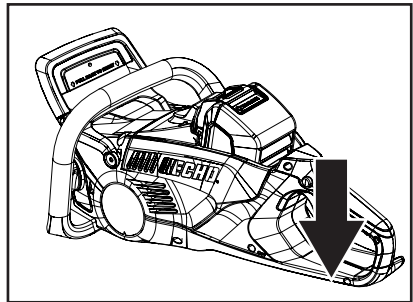

Model No. _____

Serial No. _____

Service

Service of this product during the warranty period must be performed by an Authorized ECHO Service Dealer. For the name and address of the Authorized ECHO Service Dealer nearest you, ask your retailer or call: 1-800-432-ECHO (3246). Dealer information is also available on our Web Site www.echo-usa.com. When presenting your unit for Warranty service/repairs, proof of purchase is required.

ECHO Consumer Product Support

If you require assistance or have questions concerning the application, operation, or maintenance of this product, call the ECHO Consumer Product Support Department at 1-800-432-ECHO (3246) from 8:00 am to 5:00 pm (Central Standard Time) Monday through Friday. Before calling, please know the model and serial number of your unit.

Product Registration

Register your ECHO equipment online at www.echo-usa.com or by filling out the product registration sheet included in this manual. Registering your product confirms warranty coverage and provides a direct link to ECHO if we find it necessary to contact you.

Additional Literature

In addition to finding information online, information is available from your Authorized ECHO Service Dealer, or by contacting ECHO Incorporated, 400 Oakwood Road, Lake Zurich, IL 60047, 1-800-432-ECHO (3246).

CONTENTS

The ECHO product you purchased has been factory pre-assembled for your convenience. Due to packaging restrictions, some assembly may be necessary.

After opening the carton, check for damage. Immediately notify your retailer or ECHO Dealer of damaged or missing parts. Use the contents list to check for missing parts.

- 1 Chainsaw
- 1 Operator's Manual
- 1 Guide bar scabbard
- 1 Wrench

NOTICE

For a complete list of compatible batteries for this and all eFORCE tools, scan this code or visit <https://www.echo-usa.com/battery-information>



SAFETY

Manual Safety Symbols and Important Information

Throughout this manual and on the product itself, you will find safety alerts and helpful, informational messages preceded by symbols or key words. The following is an explanation of those symbols and key words and what they mean to you.

DANGER

The safety alert symbol accompanied by the word “DANGER” calls attention to an act or condition which WILL lead to serious personal injury or death if not avoided.

WARNING

The safety alert symbol accompanied by the word “WARNING” calls attention to an act or condition which CAN lead to serious personal injury or death if not avoided.

CAUTION

The safety alert symbol accompanied by the word “CAUTION” calls attention to an act or condition which might lead to minor or moderate personal injury if not avoided.

NOTICE

The enclosed message provides information necessary for the protection of the unit.

Note: This enclosed message provides tips for use, care and maintenance of the unit.

















CIRCLE AND SLASH SYMBOL

This symbol means the specific action shown is prohibited. Ignoring these prohibitions can result in serious or fatal injury.

International Symbols

Some of the following symbols may be used on this product. Please study them and learn their meaning. Proper interpretation of these symbols will allow you to operate the product better and safer.

Symbol	Description	Symbol	Description
	WARNING! Read and follow all safety precautions in the operator's manual. Failure to follow instructions could result in serious personal injury.		Tip contact may cause the guide bar to move suddenly upward and backward, which may cause serious injury.
	Safety / Alert		Use appropriate protection for foot-leg and hand-arm.
	This chainsaw is for trained tree service operators only.		Contact of the guide bar tip with any object should be avoided.
	Both of the operator's hands must be used to operate the chainsaw		Direct current
	Wear Eye, Ear and Head Protection		Volts
	Chain brake operation		Beware of electric shocks
	Environmentally safe battery disposal		Chain oil fill
	Do not expose the product to rain or moist conditions.		

General Power Tool Safety Warnings

WARNING

Read all safety warnings, instructions, illustrations and specifications provided with this power tool. *Failure to follow all instructions listed below may result in electric shock, fire and/or serious injury.*

Save all warnings and instructions for future reference.

The term “power tool” in the warnings refers to your battery operated (cordless) power tool.

Work Area Safety

- **Keep work area clean and well lit.** *Cluttered or dark areas invite accidents.*
- **Do not operate power tools in explosive atmospheres, such as in the presence of flammable liquids, gases or dust.** *Power tools create sparks which may ignite the dust or fumes.*
- **Keep children and bystanders away while operating a power tool.** *Distractions can cause you to lose control.*

Electrical Safety

- **Power tool plugs must match the outlet. Never modify the plug in any way. Do not use any adapter plugs with earthed (grounded) power tools.** *Unmodified plugs and matching outlets will reduce risk of electric shock.*
- **Avoid body contact with earthed or grounded surfaces, such as pipes, radiators, ranges and refrigerators.** *There is an increased risk of electric shock if your body is earthed or grounded.*
- **Do not expose power tools to rain or wet conditions.** *Water entering a power tool will increase the risk of electric shock.*
- **Do not abuse the cord. Never use the cord for carrying, pulling or unplugging the power tool. Keep cord away from heat, oil, sharp edges or moving parts.** *Damaged or entangled cords increase the risk of electric shock.*
- **When operating a power tool outdoors, use an extension cord suitable for outdoor use.** *Use of a cord suitable for outdoor use reduces the risk of electric shock.*
- **If operating a power tool in a damp location is unavoidable, use a RESIDUAL CURRENT DEVICE (RCD) protected supply.** *Use of an RCD reduces the risk of electric shock.*

Personal Safety

- **Stay alert, watch what you are doing and use common sense when operating a power tool. Do not use a power tool while you are tired or under the influence of drugs, alcohol or medication.** *A moment of inattention while operating power tools may result in serious personal injury.*
- **Use personal protective equipment. Always wear eye protection.** *Protective equipment such as a dust mask, non-skid safety shoes, hard hat or hearing protection used appropriately will reduce personal injuries.*
- **Prevent unintentional starting. Ensure the switch is in the off position before connecting to power source and/or battery and when picking up or carrying the tool.** *Carrying power tools with your finger on the switch or energizing power tools that have the switch on invites accidents.*
- **Remove any adjusting key or wrench before turning the power tool on.** *A wrench or a key left attached to a rotating part of the power tool may result in personal injury.*
- **Do not over-reach. Keep proper footing and balance at all times.** *This enables better control of the power tool in unexpected situations.*
- **Dress properly. Do not wear loose clothing or jewelry. Keep your hair, clothing and gloves away from moving parts.** *Loose clothes, jewelry or long hair can be caught in moving parts.*
- **If devices are provided for the connection of dust extraction and collection facilities, ensure these are connected and properly used.** *Use of dust collection can reduce dust related hazards.*
- **Do not let familiarity gained from frequent use of tools allow you to become complacent and ignore tool safety principles.** *A careless action can cause severe injury within a fraction of a second.*

Power Tool Use and Care

- **Do not force the power tool. Use the correct power tool for your application.** *The correct power tool will do the job better and safer at the rate for which it was designed.*
- **Do not use the power tool if the switch does not turn it on and off.** *Any power tool that cannot be controlled with the switch is dangerous and must be repaired.*
- **Disconnect the plug from the power source and/or remove the battery, from the power tool before making any adjustments, changing accessories, or storing power tools.** *Such preventive safety measures reduce the risk of starting the power tool accidentally.*
- **Store idle power tools out of the reach of children and do not allow persons unfamiliar with the power tool or these instructions to operate the power tool.** *Power tools are dangerous in the hands of untrained users.*
- **Maintain power tools and accessories. Check for misalignment or**

binding of moving parts, breakage of parts and any other condition that may affect the power tool's operation. If damaged, have the power tool repaired before use. Many accidents are caused by poorly maintained power tools.

- **Keep cutting tools sharp and clean.** Properly maintained cutting tools with sharp cutting edges are less likely to bind and are easier to control.
- **Use the power tool and accessories in accordance with these instructions, taking into account the working conditions and the work to be performed.** Use of the power tool for operations different from those intended could result in a hazardous situation.
- **Keep handles and grasping surfaces dry, clean and free from oil and grease.** Slippery handles and grasping surfaces do not allow for safe handling and control of the tool in unexpected situations.

Battery Tool Use and Care

- **Recharge only with ECHO eFORCE® 56V battery series chargers.** A charger that is suitable for one type of battery may create a risk of fire when used with another battery.
- **Use only with ECHO eFORCE® 56V battery series.** Use of any other batteries may create a risk of injury and fire.
- **When battery is not in use, keep it away from other metal objects like paper clips, coins, keys, nails, screws, or other small metal objects that can make a connection from one terminal to another.** Shorting the battery terminals together may cause burns or fire.
- **Do not open or destroy the battery.** Electrolytes contained within the battery are corrosive and may cause damage to eyes or skin if released. It may be toxic if swallowed.
- **Under abusive conditions, liquid may be ejected from the battery; avoid contact. If contact accidentally occurs, flush with water. If liquid contacts eyes, additionally seek medical help.** Liquid ejected from the battery may cause irritation or burns.
- **Exercise care in handling batteries to avoid shorting the battery with conducting materials such as rings, bracelets, keys, etc.** The battery or conductor may overheat and cause burns if contact with said materials is made.
- **Do not use a battery or tool that is damaged or modified.** Damaged or modified batteries may exhibit unpredictable behavior resulting in fire, explosion or risk of injury.
- **Do not expose a battery or tool to fire or excessive temperature.** Exposure to fire or temperature above 266°F (130°C) may cause explosion.
- **Follow all charging instructions and do not charge the battery or tool outside the temperature range specified in the instructions.** Charging improperly or at temperatures outside the specified range may damage the battery and increase the risk of fire.

Child Safety

Tragic accidents can occur if the operator is not aware of the presence of children.

- Keep children out of the working area and under the watchful care of a responsible adult.
- Do not allow children to operate this machine.
- Stay alert, and turn the machine off if a child or any other person enters the working area.
- Use extreme care when approaching blind corners, doorways, shrubs, trees, or other objects that may obscure your view of a child who may run into the path of the machine.

Service

- **Have your power tool serviced by a qualified repair person using only identical replacement parts.** *This will ensure that the safety of the power tool is maintained.*
- **Never service damaged batteries.** *Service of batteries should only be performed by the manufacturer or authorized service providers.*

General Chainsaw Safety Warnings

WARNING

- **Keep all parts of the body away from the saw chain when the chainsaw is operating. Before you start the chainsaw, make sure the saw chain is not contacting anything.** *A moment of inattention while operating chainsaws may cause entanglement of your clothing or body with the saw chain.*
- **Always hold the chainsaw with your right hand at the rear handle and your left hand at the front handle.** *Holding the chainsaw with a reversed hand configuration increases the risk of personal injury and should never be done.*
- **Hold the chainsaw by insulated gripping surfaces only, because the saw chain may contact hidden wiring.** *Saw chains contacting a "live" wire may make exposed metal parts of the chainsaw "live" and could give the operator an electric shock.*
- **Wear eye protection. Further protective equipment for hearing, head, hands, legs and feet is recommended.** *Adequate protective equipment will reduce personal injury from flying debris or accidental contact with the saw chain.*
- **Do not operate a chainsaw in a tree, on a ladder, from a rooftop, or any unstable support.** *Operation of a chainsaw in this manner could result in serious personal injury.*

- **Always keep proper footing and operate the chainsaw only when standing on fixed, secure and level surface.** *Slippery or unstable surfaces may cause a loss of balance or control of the chainsaw.*
- **When cutting a limb that is under tension, be alert of spring back.** *When the tension in the wood is released, the spring loaded limb may strike the operator and/or throw the chainsaw out of control.*
- **Use extreme caution when cutting brush and saplings.** *The slender material may catch the saw chain and be whipped toward you or pull you off balance.*
- **Carry the chainsaw by the front handle with the chainsaw switched off and away from your body. When transporting or storing the chainsaw, always install the guide bar scabbard.** *Proper handling of the chainsaw will reduce the likelihood of accidental contact with the moving saw chain.*
- **Follow instructions for lubricating, chain tensioning and changing the bar and chain.** *Improperly tensioned or lubricated chain may either break or increase the chance for kickback.*
- **Cut wood only. Do not use chainsaw for purposes not intended. For example: do not use chainsaw for cutting metal, plastic, masonry or non-wood building materials.** *Use of the chainsaw for operations different than intended could result in a hazardous situation.*
- **Do not attempt to fell a tree until you have an understanding of the risks and how to avoid them.** *Serious injury could occur to the operator or bystanders while felling a tree.*
- **Follow all instructions when clearing jammed material, storing or servicing the chainsaw. Make sure the trigger switch is off and the battery is removed.** *Unexpected actuation of the chainsaw while clearing jammed material or servicing may result in serious personal injury.*

Recommended Ambient Temperature:

	Charging		Usage/Discharging		Storage	
	Low	High	Low	High	Low	High
Product ⁽¹⁾	Not Applicable		32°F (0°C)	113°F (45°C)	32°F (0°C)	113°F (45°C)
Battery ⁽²⁾⁽³⁾	39°F (4°C)	104°F (40°C)	32°F (0°C)	113°F (45°C)	32°F (0°C)	113°F (45°C)
Charger	39°F (4°C)	104°F (40°C)	Not Applicable		32°F (0°C)	113°F (45°C)

⁽¹⁾ Assumes the battery is just off the charger or stored at the temperature range noted for Charger Usage 39° F (4°C) - 104°F (40°C).

⁽²⁾ Hot batteries in high ambient temperatures require longer charge times.

⁽³⁾ To maximize battery life of batteries being stored more than 3 months, ECHO recommends batteries being stored at 3 green lights on the battery capacity indicator (BCI) and at room temperature.

Note: Long term storage of batteries in conditions or charge levels on the battery capacity indicator (BCI) other than noted above could degrade the performance and runtime of the battery.

FCC Statement

This device complies with Part 15 of the FCC Rules. Operation is subject to the following two conditions:

- This device may not cause harmful interference.
- This device must accept any interference received, including interference that may cause undesired operation.

CAUTION

Changes or modifications not expressly approved by the party responsible for compliance could void the user's authority to operate the equipment.

NOTICE

This equipment has been tested and found to comply with the limits for a Class B digital device, pursuant to Part 15 of the FCC Rules. These limits are designed to provide reasonable protection against harmful interference in a residential installation. This equipment generates, uses and can radiate radio frequency energy, and if not installed and used in accordance with the instructions, may cause harmful interference to radio or television reception. The reception can be determined by turning the equipment off and on. The user is encouraged to try to correct the interference by one or more of the following measures:

- *Reorient or relocate the receiving antenna.*
- *Increase the separation between the equipment and the receiver.*
- *Connect the equipment into an outlet on a circuit different from that to which the receiver is connected.*
- *Consult the dealer or an experienced radio/TV technician for help.*

Environmentally Safe Battery Disposal



The toxic and corrosive materials below are in the batteries used in this machine: Lithium-Ion, a toxic material.

Discard all toxic materials in a specified manner to prevent contamination of the environment. Before discarding damaged or worn out Li-ion battery, contact your local waste disposal agency, or the local Environmental Protection Agency for information and specific instructions. Take the batteries to a local recycling and/or disposal center, certified for lithium-ion disposal.

If the battery cracks or breaks, with or without leaks, do not recharge it and do not use. Discard it and replace with a new battery. **DO NOT TRY TO REPAIR IT!** To prevent injury and risk of fire, explosion, or electric shock, and to avoid damage to the environment:

Cover the terminals of the battery with heavy-duty adhesive tape.

DO NOT try to remove or destroy any of the battery components.

DO NOT try to open the battery.

If a leak develops, the released electrolytes are corrosive and toxic. **DO NOT** get the solution in the eyes or on skin, and do not swallow it.

DO NOT put these batteries in your regular household trash.

DO NOT incinerate.

DO NOT put them where they will become part of any waste landfill or municipal solid waste stream.

Take them to a certified recycling or disposal center.

Rules For Safe Operation

Causes And Operator Prevention Of Kickback

WARNING

Kickback may occur when the nose or tip of the guide bar touches an object, or when the wood closes in and pinches the saw chain in the cut.

Tip contact in some cases may cause a sudden reverse reaction, kicking the guide bar up and back towards the operator.

Pinching the saw chain along the top of the guide bar may push the guide bar rapidly back towards the operator. Either of these reactions may cause you to lose control of the saw which could result in serious personal injury. Do not rely exclusively upon the safety devices built into your saw. As a chainsaw user, you should take several steps to keep your cutting jobs free from accident or injury.

Kickback is the result of tool misuse and/or incorrect operating procedures or conditions and can be avoided by taking proper precautions as given below:

- Maintain a firm grip, with thumbs and fingers encircling the chainsaw handles, with both hands on the saw and your body and arm positioned to allow you to resist kickback forces. Kickback forces can be controlled by the operator, if proper precautions are taken. Do not let go of the chainsaw.
- Do not overreach and do not cut above shoulder height. This helps prevent unintended tip contact and enables better control of the chainsaw in unexpected situations.
- Only use replacement bars and chains specified by the manufacturer. Incorrect replacement bars and chains may cause chain breakage and/or kickback.
- Follow the manufacturer's sharpening and maintenance instructions for the saw chain. Decreasing the depth gauge height can lead to increased kickback.

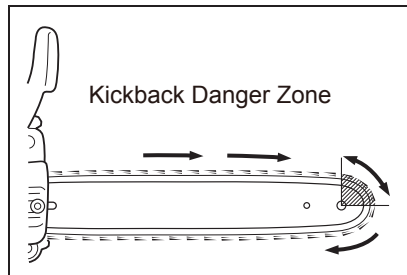
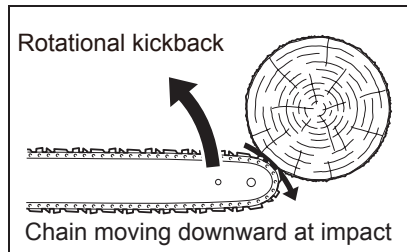

Correct Use of Chain Brake

Chain Brake

1. The chain brake's function is to stop chain rotation after a kickback.
2. It neither prevents nor reduces kickback.
3. Do not depend on the chain brake for protection against kickback.
4. Even with a chain brake, depend on your own good sense and proper cutting methods just as though there were no chain brake.
5. Even with normal use and proper maintenance, the response time of the brake may lengthen.
6. The following may interfere with the brake's ability to protect the operator:
 - Saw wrongly held too close to operator's body. Kickback time may be too fast even for a perfectly maintained brake to work in time.
 - The operator's hand may not be in position to contact the front hand guard. Brake will not be tripped.
 - Lack of proper maintenance lengthens the brake's stopping time, making it less effective.
 - Dirt, grease, oil, pitch, etc. getting into the working parts of the mechanism may lengthen the stopping time.
 - Wear and fatigue of the activating brake spring, and wear of the brake / brake drum and pivot points may lengthen the brake's stopping time.
 - A damaged front hand guard may render the brake inoperative.

Checking the function of the brake

1. Place the chainsaw on the ground.
2. Hold the handle with both hands and accelerate the motor to high speed by using the trigger switch.
3. Operate the chain brake by turning your left wrist against the front hand guard whilst gripping the front handle.
4. The chain should stop immediately.
5. Release the trigger switch.

If the chain does not stop immediately, take the chainsaw to your ECHO dealer to repair.

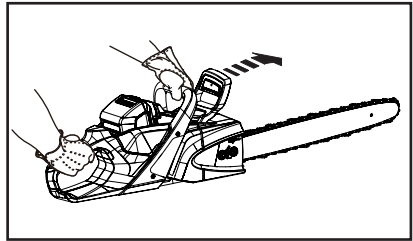

Release the chain brake

- When front hand guard is fully pulled rearward, chain brake is released.

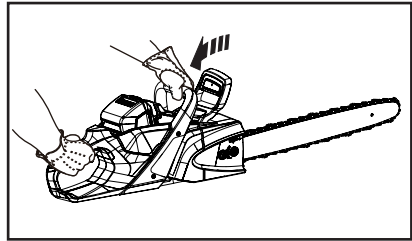

NOTICE

Do not allow the saw to tip forward in order to avoid damage to the chain.

WARNING

If the chain does not stop immediately, return the saw to your authorized dealer for repair.

Note:

- For practice, while cutting a small tree, push the lever forward to lock the brake.
- Confirm that the brake works properly before each use.
- If the chain brake is clogged with wood chips, function of the brake may deteriorate. Always keep the device clean.
- Do not increase motor RPM while the chain brake is locked.

Do not use a bar and chain combination other than those specified in this manual.

For your own safety, do not remove the chain brake system.

The installation of a chain brake may be mandatory by law or as stipulated by insurance regulations in your area of operation. You should inquire through local government offices, your employer or your local dealer to ensure that your chainsaw conforms to the required safety standard.

Chain brakes have been designed and tested to comply with international safety standards as follows:

UL 62841-1, UL 62841-4-1, CAN/CSA C22.2 No.62841-1, CAN/CSA C22.2 NO. 62841-4-1

Automatic Chain Brake

Kickback produced from the tip of the guide bar will trip the automatic chain brake. To make sure that the automatic chain brake operates properly, follow these steps:

1. Stop the motor.
2. Hold the saw with the guide bar approximately 35 cm (14 inches) above a wooden surface. Right hand should hold the rear handle, and left hand should hold the front handle.
3. Release the front handle and drop the end of the guide bar against the wooden surface.
4. The impact should lock the chain brake.

NOTICE

When checking the operation of the automatic chain brake, use a soft surface substance like wood to absorb the impact so the chain is not damaged.

DESCRIPTION

Locate the safety label(s) on your unit. Make sure the label(s) is legible and that you understand and follow the instructions on it. If a label cannot be read, a new one can be ordered from your ECHO dealer. Safety label is for example only. Your label may appear slightly different.

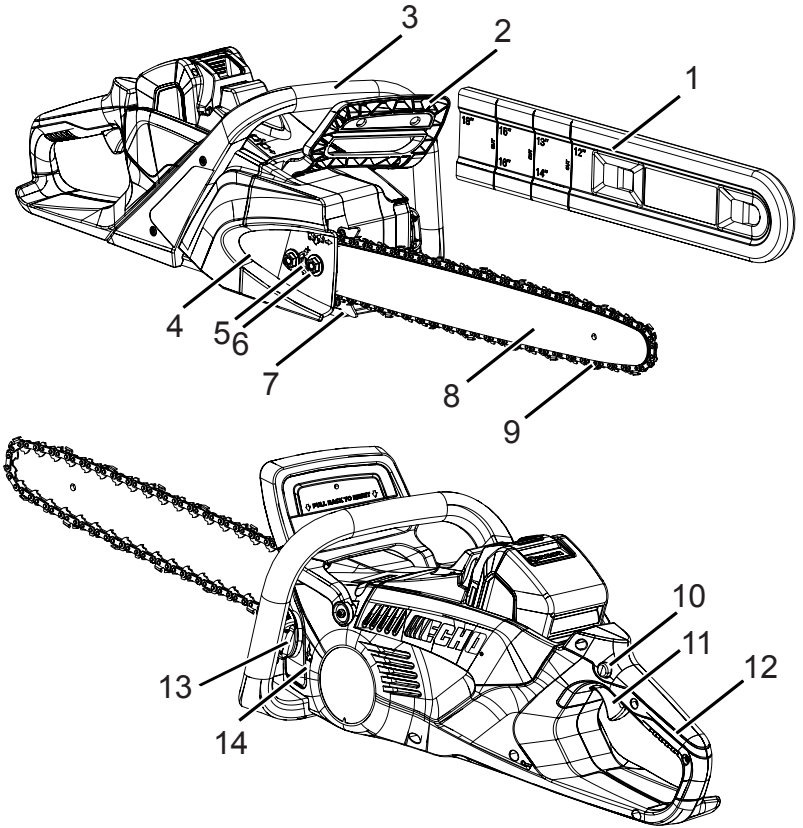

1. Guide bar scabbard
2. Front hand guard/chain brake
3. Front handle
4. Sprocket cover
5. Chain tension adjuster
6. Sprocket cover nuts
7. Spike bumpers
8. Guide bar
9. Saw chain
10. Trigger switch lockout
11. Trigger switch
12. Rear handle
13. Oil tank cap
14. Oil window

Preparation For Use

WARNING

Saw chain is sharp! Always wear gloves when handling assembly, otherwise serious personal injury may result.

Note: The machine may be delivered with guide bar and saw chain separated. Install guide bar, saw chain as follows.

Guide Bar and Saw Chain Installation / Removal

1. Release chain brake (A).
2. Loosen nuts (B) and remove sprocket cover (C).
3. Mount the guide bar (D) and slide toward sprocket (E) to make saw chain installation easier.
4. Install saw chain as shown (ensure cutters are pointing in the right direction).
5. Install the sprocket cover over the guide bar studs.

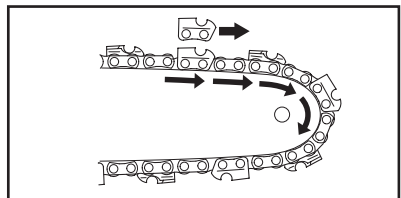
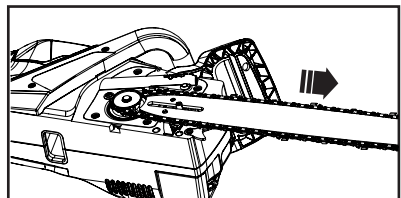
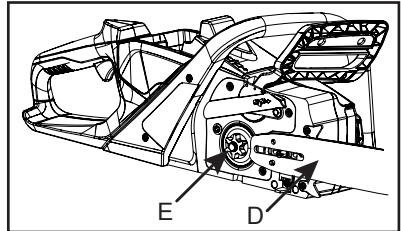
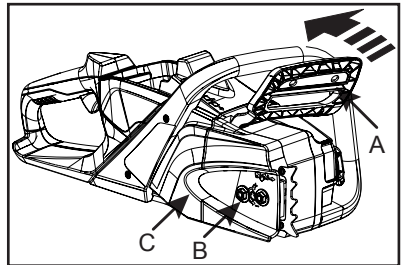

6. Tighten nuts finger tight.
7. Ensure that chain tension adjuster (F) fits into guide bar hole.
8. Hold the guide bar nose up and turn the adjuster clockwise until the chain fits snugly against the underside of the guide bar.

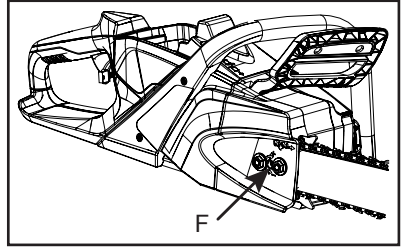

9. Tighten nuts with the guide bar nose held up.
10. Pull the chain around the guide bar by hand. Loosen the adjustment if you feel tight spots while rotating chain on the bar by hand.

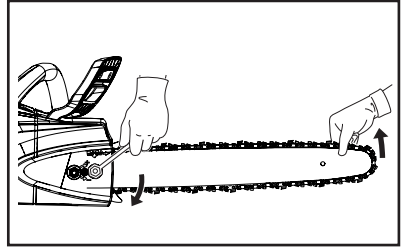

⚠ WARNING

Improper sprocket cover assembly can result in serious injury, and will cause severe saw damage if unit is started. Never start or operate saw if brake band is not in place on clutch drum. Always check chain brake operation after replacing guard. Do not use saw if chain brake does not function properly.

Adjusting Chain Tension

NOTICE

Always loosen sprocket cover nuts before turning the chain tension adjuster, otherwise the sprocket cover and tensioner will be damaged.

1. Unlock the chain brake and loosen sprocket cover nuts.
2. Hold the bar nose up, and turn the tension adjuster (F) clockwise towards (+) until chain contacts underside of the bar.

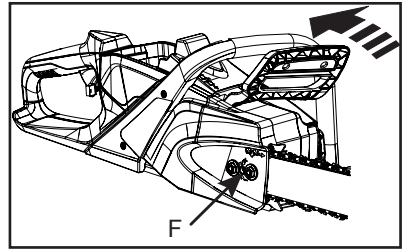

3. Tighten sprocket cover nuts with the bar nose held up and under tension.

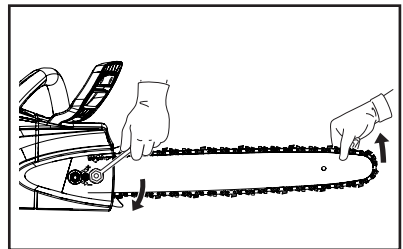

- Pull the chain around the bar by hand. Loosen the tension adjuster if you feel tight spots while rotating chain on the bar by hand.

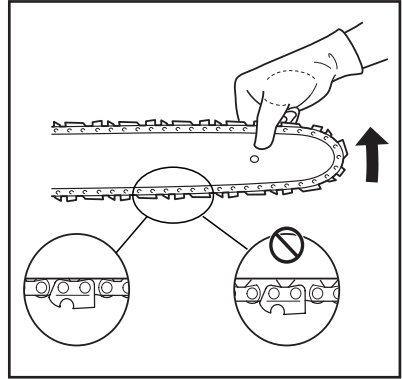

NOTICE

Tighten Sprocket Cover Nuts to 15 - 20 N•m (153 to 204 kgf•cm, 133-177 lbf•in). DO NOT over-tighten nut. Damage to saw can result.

- Assemble components in reverse order.
- Keep chain properly tensioned at all times.

Note: All chains require frequent adjustments.

Installing and Removing the Battery

WARNING

The chainsaw will operate when the battery is installed, and the trigger switch and trigger switch lockout are engaged. Make sure the chainsaw is properly positioned to prevent loss of control and possible serious injury.

Keep movable parts of the chainsaw off the ground and away from objects that could become entangled.

NOTICE

The battery comes partially charged from the factory and needs to be fully charged before first use.

Note: See separate Operator's Manual Packaged with the Battery.

Installing the Battery

1. Press front hand guard forward. (Chain brake ACTIVATED position)
2. Align ridges on battery with groove on chainsaw, and insert battery until battery latch (G) locks and a clicking sound is heard.

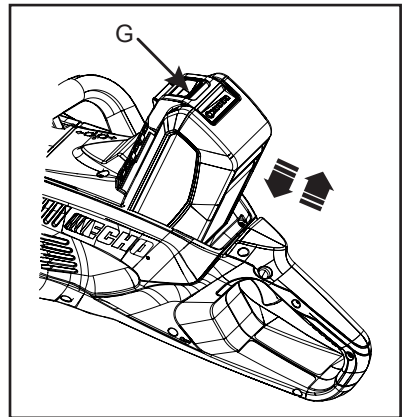

Removing the Battery

1. To remove battery, depress battery latch (G), and slide battery out of the chainsaw.

Chain Lubricant

Proper lubrication of the chain while in operation minimizes friction between the chain, the guide bar and sprocket.

Use ECHO genuine chain oil or ECHO recommended chain oil specially formulated for bars and chains for proper lubrication.

Consult your ECHO dealer for the proper chain oil.

Never use waste or reclaimed oil to avoid various malfunctions in oil system, or on chain and guide bar.

Lubrication problems caused by the use of improper oil will void the warranty.

Especially, vegetable based chain oil quickly turns to resin and adheres to oil pump, chain and guide bar.

It causes malfunctions and will shorten product life. If vegetable oil use is required due to local / municipal rule or any other reason, then flush chain oil system with mineral or chemical based chain oil after vegetable oil use.

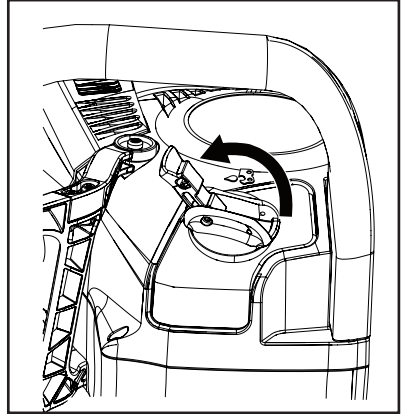

WARNING

Moving parts can amputate fingers or cause severe injuries. Keep hands, clothing and loose objects away from all openings. Always stop motor, remove battery, and make sure all moving parts have come to a complete stop before removing obstructions, clearing debris, or servicing unit.

WARNING

Operation of this equipment may create sparks that can start fires around dry vegetation. Metal cutters can also create sparks if the cutter strikes rocks, metal, or other hard objects. Contact local fire authorities for laws or regulations regarding fire prevention requirements.

Starting the unit

WARNING

When starting the unit, observe the precautions described in the "Safety" section. Failure to observe the precautions could cause an accident or injury, or even lead to a fatality.

1. Fill the chain oil tank with lubricant.
2. Remove guide bar scabbard.
3. Make sure guide bar and saw chain are not touching anything when starting the chainsaw.
4. Hold the chainsaw by both handles.
5. Hold down the trigger switch lockout (H) and depress trigger switch (I) to increase saw chain speed. If you depress trigger switch with chain brake activated, power is turned off.

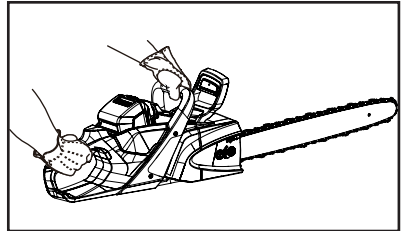

Stopping the unit

1. Release trigger switch and trigger switch lockout, and allow saw chain to stop.

Note: If the saw chain does not stop when the trigger switch and trigger switch lockout are released, remove the battery to stop the power supply to chainsaw. Have your authorized ECHO servicing dealer repair unit before using again.

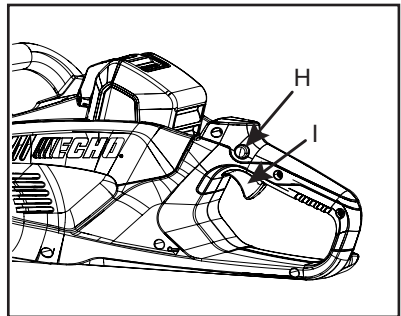

Checking Chain Tension

⚠ CAUTION

Do not operate with a loose chain. Serious injury can occur.

Chain tension should be checked frequently during work and corrected as necessary.

Tension the chain as tight as possible, but so it can still be pulled easily along the guide bar by hand.

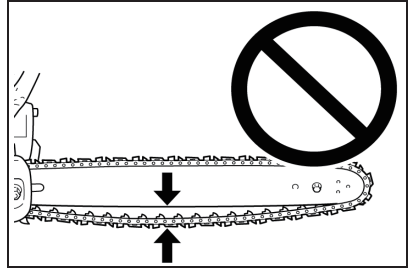

Chain Lubrication Test

Hold the chainsaw just above a dry surface and depress trigger switch to half speed for 30 seconds.

A thin line of "thrown" oil should be seen on the dry surface.

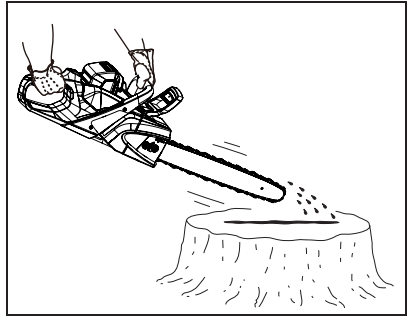

Cutting Instructions

General

⚠ WARNING

- ◆ ***This chainsaw is designed for cutting wood. Do not cut metal, plastic or any non-wood material.***
- ◆ ***Wear suitable hearing protection such as earmuffs or earplugs to protect against objectionable or uncomfortable loud noises.***

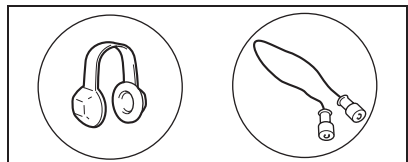

- ◆ **Do not let the tip of the bar touch anything while the motor is running. At cutting speed the chain is moving at a high rate of speed. Should the tip contact a limb or log while the chain is moving, the tip will be pushed upward with considerable force. This is known as kickback. Avoid it!**

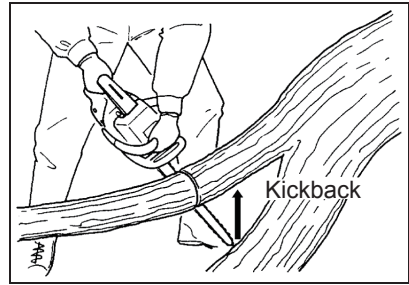

In all circumstances the operation of the chainsaw is a one-man job. It is difficult at times to take care for your own safety, so don't assume the responsibility for a helper as well. After you have learned the basic techniques of using the saw, your best aid will be your own good common sense.

The accepted way to hold the saw is to stand to the left of the saw with your left hand on the front handle and your right hand on the rear handle so you can operate the trigger switch with your right index finger. Before attempting to fell a tree, cut some small logs or limbs. Become thoroughly familiar with the controls and the responses of the saw.

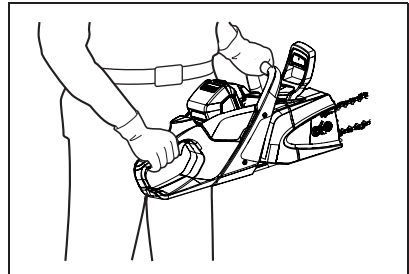

Squeeze the trigger switch to increase motor speed to maximum RPM and start the cut. If the chain is properly sharpened, the cutting should be relatively effortless. It is not necessary to press down hard to make the saw cut. Pushing the saw too hard will slow the motor speed and cutting will actually be more difficult.

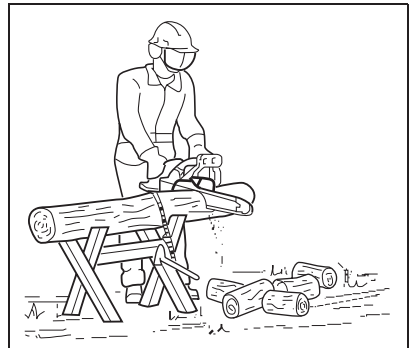

NOTICE

Sap from palm trees may corrode metal parts unless proper saw maintenance is performed. Make sure to clean metal parts from palm sap immediately after use.

- Remove sprocket guard. Clean wood chips and sawdust from guard and motor.
- Never use metal tools for cleaning which can scratch the metal paint and allow corrosion to develop.
- Clean sap accumulation from metal parts with cloth and warm water with soap.
- Rinse with clean water and dry metal surfaces.
- Apply a light coating of engine or bar and chain oil to metal parts after they are cleaned.
- Install and properly tension guide bar and chain. Run motor for one minute alternating motor speed between maximum RPM for 5 seconds and stop for 5 seconds to coat metal parts with additional protective chain oil.

CAUTION

- ◆ **Keep chain properly tensioned during operation to prevent the chain from jumping out of the guide bar rail slot and damaging motor parts.**

Felling a Tree

WARNING

A falling tree can seriously damage anything it may hit a car, a house, a fence, a power line, or another tree. There are ways to make a tree fall where you want it, so first decide where that is!

Before cutting, clear the area around the tree. You will need good footing while working and you should be able to work the saw without hitting any obstacles. Next, select a path of retreat. When the tree begins to fall you should retreat away from the direction of fall at a 45-degree angle and at least 3 m (10 ft.) from the trunk to avoid the trunk kicking back over the stump.

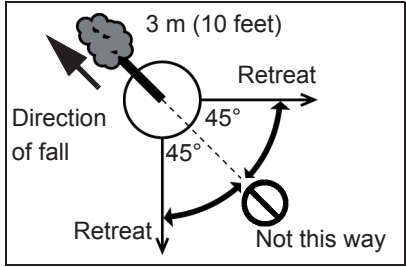

Begin the cut on the side to which the tree is to fall. Cut a notch about 1/3 of the way into the tree. The position of this notch is important since the tree will try to fall "into" the notch. The felling cut is made on the side opposite the notch and at a level about 5 cm (2 in.) above the bottom of the notch. Do not try to cut through to the notch with the felling cut.

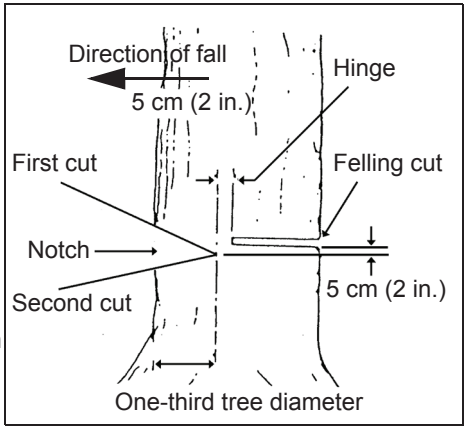

The remaining wood between the notch cut and felling cut about 5 cm (2 in.) will act as a hinge when the tree falls, guiding it in the desired direction. When the tree starts to fall, kill the motor, place the saw on the ground and make your retreat quickly.

To fell big trees with a diameter exceeding twice the bar length, start the notching cuts from one side and draw the saw through to the other side of the notch. Start the back cut on one side of the tree, pivoting the saw through to form the desired hinge on that side. Then remove the saw for the second cut. Insert the saw in the first cut, very carefully so as not to cause kickback. The final cut is made by drawing the saw forward in the cut to reach the hinge.

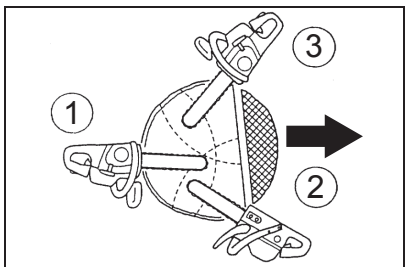

Limbing

Limbing a fallen tree is much the same as bucking. Never stand on the tree that you are limbing. When limbing, caution is the word. Be careful of the tip touching other limbs. Always use both hands.

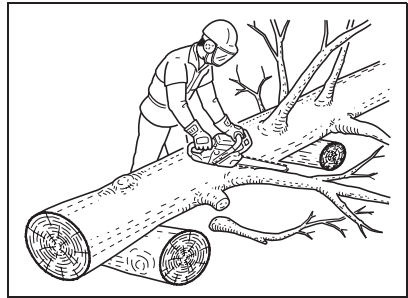

Don't cut with the saw overhead or aligned vertically with your body. If the saw should kick back, you may not have enough control to prevent possible injury.

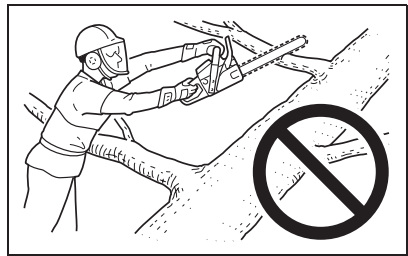

Bucking

Bucking is the sawing of a log or fallen tree into smaller pieces. There are a few basic rules which apply to all bucking operations.

- Keep both hands on the handles at all times.
- Support logs if possible.
- When cutting on a slope or hillside, always stand uphill.

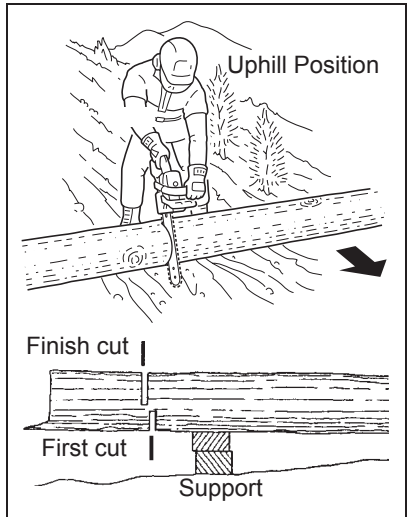

Keep in mind that the wood is heavy and that it will bend and pinch the saw if improperly supported. The trunk will weaken at the point where you make the cut unless the tree is lying on perfectly flat ground or supported as shown. If you make the cut with the tree on the ground, don't let the saw's chain dig into the earth; it is harmful for the saw, and you stand a good chance of being struck by flying debris.

To cut the trunk, use the bucking and two-cut sequence shown. The first cut should be no deeper than one-third the trunk diameter.

MAINTENANCE

WARNING

Moving parts can amputate fingers or cause severe injuries. Keep hands, clothing and loose objects away from all openings. Always stop motor, and make sure all moving parts have come to a complete stop before removing obstructions, clearing debris, or servicing unit. Allow unit to cool before performing service. Wear gloves to protect hands from sharp edges and hot surfaces.

WARNING

Operating a poorly maintained unit can result in serious injuries to operator or bystanders. Always follow all maintenance instructions as written, otherwise serious personal injury can result.

Your unit is designed to provide many hours of trouble free service. Regular scheduled maintenance will help your unit achieve that goal. If you are unsure or are not equipped with the necessary tools, we recommend that you take your unit to a Servicing Dealer for maintenance. To help you decide whether you want to DO-IT-YOURSELF or have the Dealer do it, each maintenance task has been graded. If the task is not listed, see your Dealer for repairs.

Skill Levels

Level 1 = Easy to do. Common tools may be required.

Level 2 = Moderate difficulty. Some specialized tools may be required.

Level 3 = See your dealer.

Maintenance Intervals

COMPONENT / SYSTEM	MAINTENANCE PROCEDURE	REQ'D SKILL LEVEL
Daily or Before Use		
Guide Bar & Sprocket Nose	Inspect / Clean *	1
Saw Chain	Inspect / Sharpen / Replace / Tensioning*	2
Sprocket	Inspect / Replace *	2
Screws / Nuts / Bolts	Inspect / Tighten / Replace *	1
Battery and Battery Compartment	Inspect / Clean *	1

NOTICE - Time intervals shown are maximum. Actual use and your experience will determine the frequency of required maintenance.

MAINTENANCE PROCEDURE NOTES:

* Replacement is recommended based on the finding of damage or wear during inspection.

Cleaning Battery and Battery Compartment

WARNING

Risk of electric shock or fire. Do not use conducting materials to clean battery or battery compartment.

1. Depress battery latch release and slide battery out of battery compartment.
2. Use compressed air or a soft bristle brush to remove debris from battery and battery compartment (J).

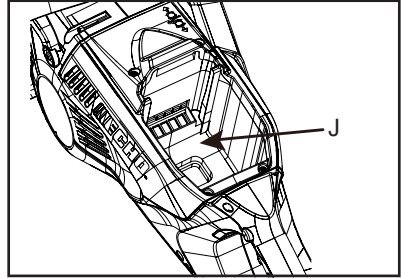

Guide Bar

1. Clean before using.
2. Clean the groove (L) of the guide bar with a small screwdriver.
3. Clean oil holes (M) with a wire.
4. Invert guide bar periodically.
5. Clean the guide bar mount area before installing the guide bar.

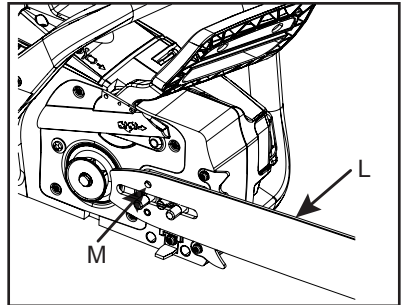

Sprocket

- A damaged sprocket will cause premature damage or wear of saw chain.
- When the sprocket has worn 0.5 mm (0.020 in.) or more, replace it.
- Check sprocket and the clutch and clean the bar mount area before installation of the bar.
- Replace either or both if worn.

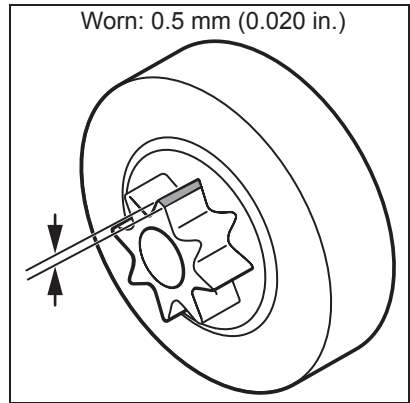

Saw Chain Maintenance

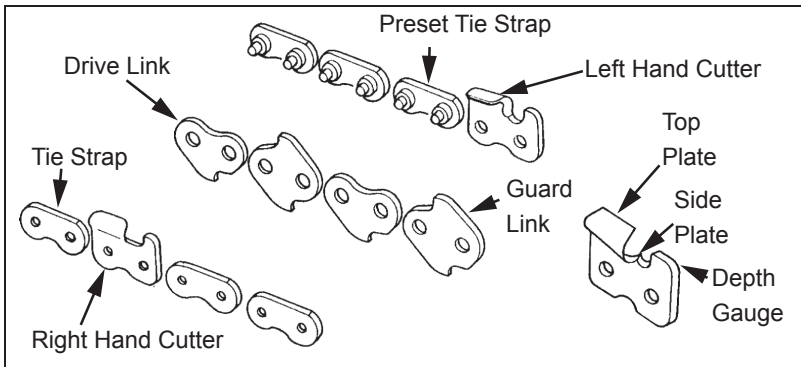

Important points for proper maintenance of saw chain:

- Keep the cutters sharp at all times.
- Keep the left and the right cutters properly aligned.
- Note that blunt or irregular cutters will result in poor cutting performance, increased vibration of chains and premature breakage of the saw chain.
- Drive link serves to remove sawdust from the groove of the guide bar. Keep the lower edge of the drive link sharp where indicated.

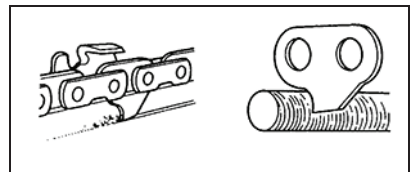

Setting Saw Chain

- 91PX Chain: Use a round 5/32" file and flat file.
- Push file as shown.
- To keep correct position and correct angle, use a file holder.

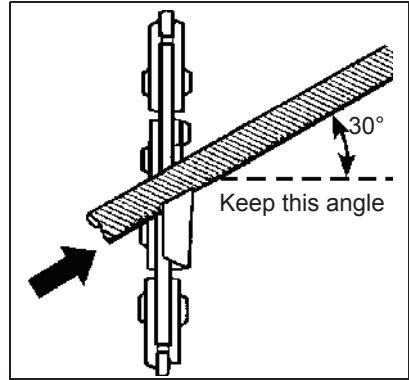

- Hold the file horizontally.

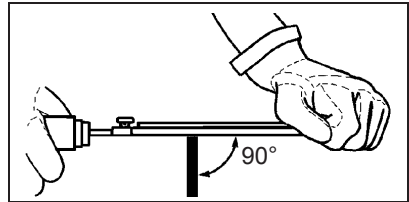

- Place the depth gauge tool firmly on guide bar so that depth gauge protrudes. Then file top of depth gauge with the flat file until flat with top of the depth gauge tool.

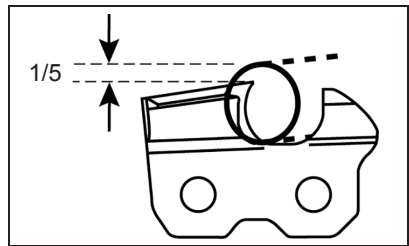

- One fifth of the file diameter remains above cutter edge.

- Be sure to round off the front edge of the depth gauge.

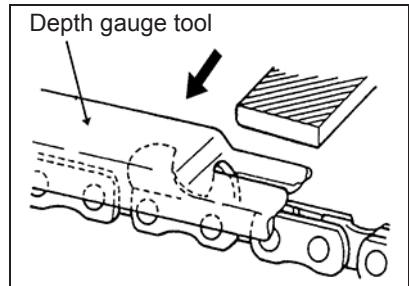

- Properly filed cutters are shown in illustration.

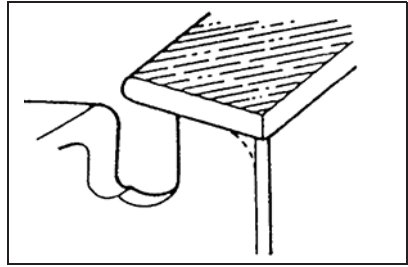

- When setting of the chain is finished, soak it in oil and wash away filings completely before using.

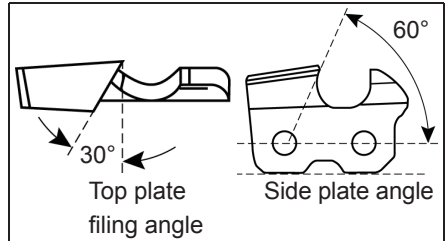

- When chain has been filed on the bar, supply sufficient oil to it, move the chain slowly to wash away the filings before using again.
- If the chainsaw is operated with filings clogged in the groove, the saw chain and the guide bar will be damaged prematurely.
- If the saw chain becomes soiled with resin, for instance, clean it with kerosene and soak in it oil.

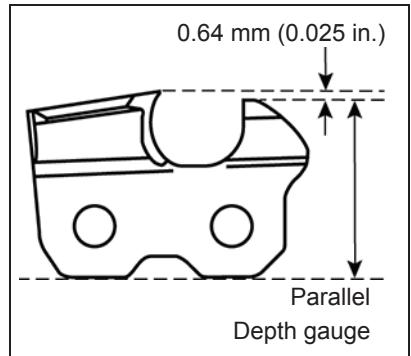

NOTICE

To sharpen other chains, follow chain manufacturer's instructions.

TROUBLESHOOTING

Problem	Cause	Solution
The guide bar and the chain become hot and release smoke.	The chain is too tight.	Adjust the chain tension.
	The oil tank is empty.	Add oil.
	Contamination causes a blockage of the discharge port.	Remove the guide bar and clean the discharge port.
	Contamination causes a blockage of the oil tank.	Clean the oil tank. Add new oil.
	Contamination causes a blockage of the guide bar and the oil tank cap.	Clean the guide bar and the oil tank cap.
	Contamination causes a blockage of the sprocket or guide wheels.	Clean the sprocket and the guide wheels.
The motor runs but the chain does not rotate.	The chain is too tight.	Adjust the chain tension.
	The guide bar and the chain are damaged.	Replace the guide bar and the chain if it is necessary.
	The motor is damaged.	<ol style="list-style-type: none"> 1. Remove the battery from the machine. 2. Remove the guide bar scabbard. 3. Remove the bar and saw chain. 4. Clean the machine. 5. Install battery and operate the machine. <p>If the sprocket rotates, it means the motor works properly. If not, call an Authorized ECHO Dealer.</p>

The motor runs and the chain rotates, but the chain does not cut.	The chain is dull.	Sharpen or replace the saw chain.
	The chain is in the incorrect direction.	Turn the chain loop to the other direction.
	The chain is tight or loose.	Adjust the chain tension.
The motor does not run.	The chain brake is engaged.	Pull the chain brake in the direction of the user to disengage it.
	The machine and battery are not connected correctly.	Make sure that the battery release button clicks when you install the battery.
	The battery level is low.	Charge the battery.
	The trigger switch lockout and the trigger switch are not pushed at the same time.	1. Push the trigger switch lockout and hold it. 2. Push the trigger switch to start the machine.
	The battery is too hot or too cold.	Refer to battery and charger manual.
The motor runs, but the chain does not cut correctly, or the motor stops after around 3 seconds.	The machine is in the protection mode.	Release the trigger switch and start the machine again. Do not force the machine to cut.
	The battery is not charged.	Charge the battery. Refer to the battery and charger manual for correct charging procedures.
	The chain is not lubricated.	Lubricate the chain to decrease the friction. Do not let the guide bar and the chain operate without sufficient oil.
	Incorrect battery storage temperature	Cool the battery until it decreases to the ambient temperature.

STORAGE

Storage After Use

When storing the product for long periods of time, ensure that the following preparations for storage are carried out.

Chainsaw

Do not store your unit without performing protective storage maintenance which includes the following:

1. Remove battery from chainsaw.
2. Remove accumulation of dirt and debris from exterior of unit.
3. Tighten all screws and nuts.
4. Install guide bar scabbard.
5. Cover battery compartment of chainsaw.
6. Store unit in a dry, dust-free place, out of the reach of children.

Battery

1. Remove battery from chainsaw.
2. Store in a dry, dust-free place, out of the reach of children.
3. Store in temperatures between 32°F (0°C) and 113°F (45°C).
4. If battery is stored for longer than six months, charge it to 100% capacity.

Charger

1. Remove battery from charger.
2. Disconnect charger from power supply.
3. Store in a dry, dust-free place, out of the reach of children.

SPECIFICATIONS

MODEL	DCS-5000
Guide bar length	18" (457 mm)
Chain pitch	3/8" LP (9.5 mm)
Chain gauge	0.050" (1.27 mm)
Drive links	62
Oil tank capacity	7.4 oz (220 ml)
Chain speed	10500 RPM (20 m/s)
Guide bar	18A0CD3762
Saw chain	91P062X/91PX62CQ
Weight	10.25 lbs (4.65 kg)
Battery:	
Model	ECHO eFORCE® 56V battery series batteries
Type	Li-Ion
Voltage	56 (rated 50.4)
Charger type	CCCV
Charger input voltage	120V AC 60Hz
Charger model	ECHO eFORCE® 56V battery series charger
Charger Lights	
○ OFF ◌ Green blinking	Battery is charging
○ OFF ● Green	Fully charged
● Red ○ OFF	Battery is too warm: (Remove for approx.30 minutes to allow to cool)
◌ Red ○ OFF blinking	Defective battery: (Remove and replace with new battery if this occurs)
Charge Time	See Battery Operator's Manual

PRODUCT REGISTRATION

Thank you for choosing ECHO Power Equipment

Please go to <http://www.echo-usa.com/Warranty/Register-Your-ECHO> to register your new product online. It's FAST and EASY! NOTE: your information will never be sold or misused by ECHO, Incorporated.

Registering your purchase enables us to contact you in the unlikely event of a service update or product recall, and verifies your ownership for warranty consideration.

If you do not have access to the Internet, you can complete the form below and mail to:

***ECHO Incorporated, Product Registration, PO Box 1139,
Lake Zurich, IL 60047.***



PRODUCT REGISTRATION CARD : TARJETA DE REGISTRO : CARTE D'ENREGISTREMENT DU PRODUIT

ONLINE OPTION: Register online and save a stamp! You will be alerted of product updates and/or be sent new ECHO product information and special offers. Simply go to: www.echo-usa.com

OPCIÓN POR INTERNET: Regístrese en la página web y ahorre un sello. Usted será alertado de actualizaciones de productos ECHO y las ofertas especiales. Simplemente visite: www.echo-usa.com

OPTION EN LIGNE: Enregistrer en ligne et épargner un timbre! Vous serez informé sur les nouveaux produits ECHO et les offres spéciales. Simplemente visitez: www.echo-usa.com

Please Print : Por Favor Escribe Con Letra De Moldé : En Lettre Carré S.V.P.

Confidential: Information provided will not be shared or sold

Purchaser's Name : Nombre del Comprador : Nom de l'acheteur	
Address : Dirección : Adresse	
City : Ciudad : Ville	State : Estado : Zip Code : Código Postal : Code Postal / Province
E-Mail Address : Dirección De Correo Electrónico : Courrier Electronique	
Phone Number : Número De Teléfono : Téléphone	Date of Purchase : Fecha de la Compra : Date de l'achat
Where Purchased : Nombre del Almacén donde fue Comprado : Lieu d'achat	
Model Number : Número del Modelo : No. de modelo	Serial Number : Número de Serie : No. de série

Registering your purchase enables us to contact you in the unlikely event of a service update or product recall and verifies your ownership in the event of loss. El registrar su compra nos permite estar en contacto con usted en caso de cualquier evento de actualización de servicio o llamado de atención de un producto. El enregistrement de votre achat nous permettra de vous contacter dans le cas improbable de modifications des instructions d'entretien ou de rappel du produit et vérifier que vous êtes le propriétaire en cas de vol ou de perte.

Primary use of tool: Professional Homeowner Rental Equip.
 Uso primario de la herramienta: Profesional Dueño de casa Alquiler
 Usage principal: Profesional Residential Location
 Do you wish to receive periodic ECHO product information and special offers by e-mail? Yes No
 ¿Desea usted recibir información periódica y ofertas especiales por correo electrónico sobre el producto ECHO? Yes No
 Souhaitez-vous recevoir périodiquement de l'information sur les produits ECHO et les offres spéciales par courrier électronique? Oui Non
 Did you visit the ECHO website before purchasing your product?
 Yes No
 Visitéz usted la página web ECHO antes de comprar su producto?
 Si No
 Avez-vous visité le site d'ECHO avant de procurer votre produit?
 Oui Non

What factor(s) most influenced your purchase?
 Performance Dealer
 Reliability Price
 Friend/Family Prior Experience Quality
 Brand Warranty
 ¿Qué factor(es) influyó más en su compra?
 Funcionamiento Precio Distribuidor
 Confiablez Calidad Experiencia Anterior
 Amigo/Familia Marca Garantía

Quel facteur (facteurs) vous a influencé le plus?
 Performance Prix Marchand
 Fiabilité Expérience Qualité
 Ami/Famille Marque Garantie

ECHO INC., 400 Oakwood Rd., Lake Zurich, IL 60047
 1.800.432.ECHO WWW.ECHO-USA.COM

X75722720206 02-2012



Limited Warranty Statement for ECHO 56 Volt Handheld Products and Walk Behind Mowers sold in USA and Canada

ECHO Incorporated warrants to the original retail purchaser that this ECHO brand 56 Volt outdoor product is free from defects in material and workmanship and agrees to repair or replace, at ECHO Incorporated's discretion, any defective product free of charge within these time periods from the date of purchase:

- If the product is for homeowner use:
 - Units and Bare Tool – 5 Years
 - Battery or charger – 2 years
- If the product is for commercial use:
 - Units and Bare Tool – 2 years
 - Battery or charger – 2 years
- If the product is for rental use: 90 days for all units, batteries, and chargers.
- Cutting attachments such as, but not limited to, bars, chains, sprockets, blades, tines, belts, PowerBroom™ and nylon trimmer heads for homeowner or non-income producing use will be covered for failures due to defects in material or workmanship for a period of 60 days from original product purchase date and 30 days for commercial / rental use. Any misuse from contact with concrete, rocks, or other structures is not covered by this warranty.

This warranty extends to the original retail purchaser only and commences on the date of the original retail purchase.

Any part of this product found in the reasonable judgment of ECHO Incorporated, to be defective in material or workmanship will be repaired or replaced without charge for parts and labor by an authorized ECHO dealer. Units, repair parts and accessories replaced under this warranty are warranted only for the balance of the original warranty period.

The product, including any defective part, must be returned to an authorized ECHO dealer within the warranty period. The expense of delivering the product to the service center for warranty work and the expense of returning it back to the owner after repair or replacement will be paid by the owner. ECHO Incorporated's, responsibility in respect to claims is limited to making the required repairs or replacements and no claim of breach of warranty shall be cause for cancellation or rescission of the contract of sale of any ECHO brand 56 Volt outdoor product. Proof of purchase will be required by the dealer to substantiate any warranty claim. All warranty work must be performed by an authorized ECHO dealer.

This warranty does not cover any units, battery or charger that has been subject to misuse, neglect, negligence, or accident, or that has been operated in any way contrary to the operating instructions as specified in the Operator's Manual. This warranty does not cover normal deterioration due to the use

or exposure, and any repairs made necessary by normal wear, improper maintenance, improper lubrication, improper storage, dirt, abrasives, impact, moisture, water, rain, snow, rust, corrosion, varnish, or other similar conditions.

This warranty does not cover damage to chargers or batteries by improper charging voltage and batteries that have been exposed to temperatures beyond those specified in the Operator's Manual, batteries that have not been properly charged or batteries that have reached their useful life.

This warranty does not apply to any damage to the product that is the result of improper maintenance or to any product that has been altered or modified. The warranty does not extend to repairs made necessary by normal wear or by the use of parts or accessories which are either incompatible with the ECHO brand 56 Volt outdoor product or adversely affect its operation, performance, or durability. In addition, this warranty does not cover wear to normal items such as, but not limited to:

Wear items – Bump Knobs, Outer Spools, Cutting Lines, Inner Reels, Felt Washers, Hitch Pins, Mulching Blades, Blower Fans, Blower and Vacuum Tubes, Vacuum Bag and Straps, Guide Bars, Saw Chains, Grass Catch Bag, Hedge Trimmer Blades, and Wheels

ECHO Incorporated, reserves the right to change or improve the design of this product without assuming any obligation to modify any product previously manufactured.

All implied warranties are limited in duration to the stated warranty period. Accordingly, any such implied warranties including merchantability, fitness for a particular purpose, or otherwise, are disclaimed in their entirety after the expiration of the appropriate five-year, two-year, one-year, 90-day, 60-day, or 30-day warranty period. ECHO Incorporated's obligation under this warranty is strictly and exclusively limited to the repair or replacement of defective parts. ECHO Incorporated, does not assume or authorize anyone to assume for them any other obligation. Some states do not allow limitations on how long an implied warranty lasts, so the above limitation may not apply to you. ECHO Incorporated, assumes no responsibility for incidental, consequential, or other damages including, but not limited to, expense of returning the product to an authorized dealer for ECHO brand 56 Volt outdoor products and expense of delivering it back to the owner, mechanic's travel time, telephone charges, rental of a like product during the time warranty service is being performed, travel, loss or damage to personal property, loss of revenue, loss of use of the product, loss of time, or inconvenience. Some states do not allow the exclusion or limitation of incidental or consequential damages, so the above limitation or exclusion may not apply to you.

This warranty gives you specific legal rights, and you may also have other rights which vary from state to state.

This warranty applies to all ECHO brand 56 Volt outdoor products manufactured by or for ECHO Incorporated, and sold in the United States and Canada.

To locate your nearest authorized ECHO dealer, visit www.ECHO-usa.com or dial 1-800-432-ECHO (3246).

NOTES



401CSR100001 - 401CSR999999
419CSR100001 - 419CSR999999



ECHO INCORPORATED

400 Oakwood Road

Lake Zurich, IL 60047

www.echo-usa.com