



Power Blower

Operator's Manual

MODEL: PB-755H
PB-755T

WARNING  **DANGER**



The muffler or catalytic muffler and surrounding cover may become extremely hot.

Always keep clear of exhaust and muffler area, otherwise serious personal injury may occur.



WARNING



The engine exhaust from this product contains chemicals known to the State of California to cause cancer, birth defects or other reproductive harm.



WARNING  **DANGER**

Read rules for safe operation and all instructions carefully. ECHO provides this Operator's Manual which must be read and understood for proper and safe operation.

INTRODUCTION

Welcome to the ECHO family. This ECHO product was designed and manufactured to provide long life and on-the-job-dependability. Read and understand this manual. You will find it easy to use and full of helpful operating tips and SAFETY messages.

THE OPERATOR'S MANUAL

Read and understand this manual before operation. Keep it in a safe place for future reference. It contains specifications and information for operation, starting, stopping, maintenance, storage and assembly specific to this product.

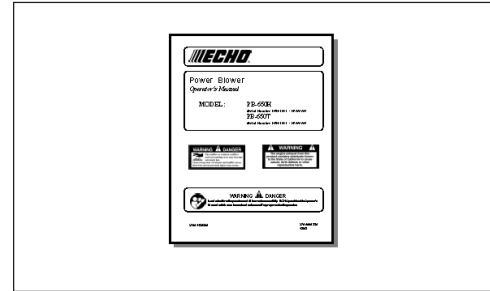

TABLE OF CONTENTS

Introduction	2	Maintenance	18
- The Operator's Manual	2	- Skill Levels	18
Safety	3	- Maintenance Intervals	18
Manual Safety Symbols and Important Information ..	3	- Air Filter	19
- International Symbols	3	- Fuel Filter	20
- Personal Condition and Safety Equipment	3	- Spark Plug	20
- Equipment	6	- Cooling System	21
Emission Control	6	- Exhaust System	22
Description	7	- Carburetor Adjustment	23
Contents	11	Troubleshooting	24
Assembly	12	Storage	25
- Install Blower Pipes / Stick Handle PB-755H	12	Specifications	26
- Install Blower Pipes PB-755T	13	Servicing Information	28
Operation	14	- Parts/Serial Number	28
- Fuel	14	- Service	28
- Starting Cold Engine	15	- ECHO Consumer Product Support	28
- Starting Warm Engine	16	- Warranty Card	28
- Stopping Engine	16	- Additional or Replacement Manuals	28
- Operating Blower	17		

Specifications, descriptions and illustrative material in this literature are as accurate as known at the time of publication, but are subject to change without notice. Illustrations may include optional equipment and accessories, and may not include all standard equipment.

SAFETY

MANUAL SAFETY SYMBOLS AND IMPORTANT INFORMATION

Throughout this manual and on the product itself, you will find safety alerts and helpful, informational messages preceded by symbols or key words. The following is an explanation of those symbols and key words and what they mean to you.

 This symbol accompanied by the words **WARNING** and **DANGER** calls attention to an act or condition that can lead to serious personal injury to operator and bystanders.











 The circle with the slash symbol means whatever is shown within the circle is prohibited.









 **IMPORTANT**  **NOTE**

IMPORTANT
The enclosed message provides information necessary for the protection of the unit.

NOTE
This enclosed message provides tips for use, care and maintenance of the unit.

INTERNATIONAL SYMBOLS

Symbol form/shape	Symbol description/application	Symbol form/shape	Symbol description/application
	Read and understand Operator's Manual.		Fuel and oil mixture
	Wear eyes, ears and head protection		Finger Severing
	Hot Surface		Wear hand protection. Use two handed.
	Safety/Alert		Wear slip resistant foot wear.
	DO NOT allow flames or sparks near fuel.		DO NOT smoke near fuel.

Symbol form/shape	Symbol description/application	Symbol form/shape	Symbol description/application
	Emergency stop		Ignition ON/OFF
	Carburetor adjustment - Low speed mixture		Primer bulb
	Carburetor adjustment - Idle speed		Carburetor adjustment - High speed mixture
	Choke Control "Cold Start" Position (Choke Closed)		Choke Control "Run" Position (Choke Open)

PERSONAL CONDITION AND SAFETY EQUIPMENT

WARNING  DANGER

Power Blower users risk injury to themselves and others if the power blower is used improperly or safety precautions are not followed. Proper clothing and safety gear must be worn when operating a blower.

Physical Condition

Your judgment and physical dexterity may not be good:

- if you are tired or sick,
- if you are taking medication,
- if you have taken alcohol or drugs.

Operate unit only if you are physically and mentally well.

Eye Protection

Wear eye protection that meets ANSI Z87.1 or CE requirements whenever you operate the unit.

Hand Protection

Wear no-slip, heavy-duty work gloves to improve your grip on the blower handle. Gloves also reduce the transmission of machine vibration to your hands.

Breathing Protection

Wear a facemask to protect against dust.

Hearing Protection

ECHO recommends wearing hearing protection whenever unit is used.

Proper Clothing

Wear snug fitting, durable clothing;

- Pants should have long legs, shirts with long sleeves.
- **DO NOT WEAR SHORTS,**
- **DO NOT WEAR TIES, SCARVES, and JEWELRY.**

Wear sturdy work shoes with nonskid soles:

- **DO NOT WEAR OPEN TOED SHOES,**
- **DO NOT OPERATE UNIT BAREFOOTED.**

Keep long hair away from engine and blower intake. Retain hair with cap or net.

Hot Humid Weather

Heavy protective clothing can increase operator fatigue, which may lead to heat stroke. Schedule heavy work for early morning or late afternoon hours when temperatures are cooler.

Vibration and Cold

It is believed that a condition called Raynaud's Phenomenon, which affects the fingers of certain individuals, may be brought about by exposure to vibration and cold. Exposure to vibration and cold may cause tingling and burning sensations, followed by loss of color and numbness in the fingers. The following precautions are strongly recommended, because the minimum exposure, which might trigger the ailment, is unknown.

- Keep your body warm, especially the head, neck, feet, ankles, hands, and wrists.
- Maintain good blood circulation by performing vigorous arm exercises during frequent work breaks, and also by not smoking.
- Limit the hours of operation. Try to fill each day with jobs where operating the unit or other hand-held power equipment is not required.
- If you experience discomfort, redness, and swelling of the fingers followed by whitening and loss of feeling, consult your physician before further exposing yourself to cold and vibration.



Repetitive Stress Injuries

It is believed that overusing the muscles and tendons of the fingers, hands, arms, and shoulders may cause soreness, swelling, numbness, weakness, and extreme pain in those areas. Certain repetitive hand activities may put you at a high risk for developing a Repetitive Stress Injury (RSI). An extreme RSI condition is Carpal Tunnel Syndrome (CTS), which could occur when your wrist swells and squeezes a vital nerve that runs through the area.

Some believe that prolonged exposure to vibration may contribute to CTS. CTS can cause severe pain for months or even years.

To reduce the risk of RSI/CTS, do the following:

- Avoid using your wrist in a bent, extended, or twisted position. Instead try to maintain a straight wrist position. Also, when grasping, use your whole hand, not just the thumb and index finger.
- Take periodic breaks to minimize repetition and rest your hands.
- Reduce the speed and force with which you do the repetitive movement.
- Do exercises to strengthen the hand and arm muscles.
- Immediately stop using all power equipment and consult a doctor if you feel tingling, numbness, or pain in the fingers, hands, wrists, or arms. The sooner RSI/CTS is diagnosed, the more likely permanent nerve and muscle damage can be prevented.

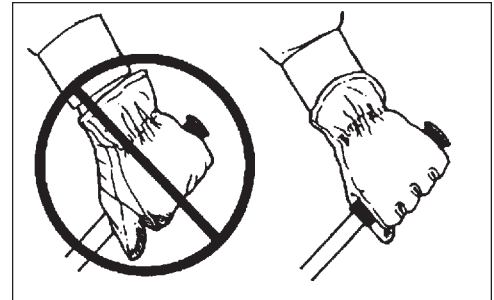

WARNING DANGER

Do not operate this product indoors or in inadequately ventilated areas. Engine exhaust contains poisonous emissions and can cause serious injury or death.

Read the Manuals

- Provide all users of this equipment with the Operator's Manual and Safety Manual for instructions on Safe Operation.

Clear the Work Area

- Spectators and fellow workers must be warned, and children and animals prevented from coming nearer than 15 m (50 ft.) while the unit is in use.
- Take wind conditions into account: avoid open doors and windows.
- Do not point blower at people or animals.

Keep a Firm Grip

- Hold the front and rear handles with both hands, with thumbs and fingers encircling the handles.

Keep a Solid Stance

- Maintain footing and balance at all times. Do not stand on slippery, uneven or unstable surfaces. Do not work in odd positions or on ladders. Do not over reach.

Avoid Hot Surfaces

- Keep exhaust area clear of flammable debris. Avoid contact during and immediately after operation.

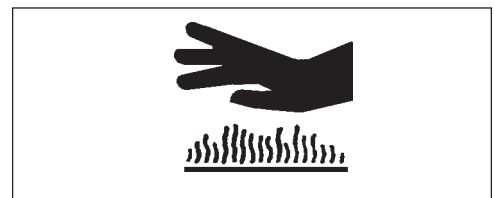

EQUIPMENT CHECK

WARNING DANGER

Use only ECHO approved attachments. Serious injury may result from the use of a non-approved attachment combination. ECHO, INC. will not be responsible for the failure of cutting devices, attachments or accessories which have not been tested and approved by ECHO. Read and comply with all safety instructions listed in this manual and safety manual.

- Check unit for loose/missing nuts, bolts and screws. Tighten and/or replace as needed.
- Inspect fuel lines, tank and area around carburetor for fuel leaks. **DO NOT** operate unit if leaks are found.
- Do not use blower if any part is missing or damaged.
- Have repairs done only by an authorized ECHO Service dealer.
- Do not use any attachment, accessory or replacement part unless it is recommended in this Operator's Manual.

EMISSION CONTROL

EPA Phase 2

The emission control system for these engines is EM/TWC (Engine and Catalyst Modification).

IMPORTANT ENGINE INFORMATION
ENGINE FAMILY: 6EHXS.0635KB DISPLACEMENT: 63.3 cc
EMISSION COMPLIANCE PERIOD: 300 Hours
THIS ENGINE MEETS U.S. EPA PH2 AND 2005 - 2006
CALIFORNIA EMISSION REGULATIONS FOR SOREs.
REFER TO OWNER'S MANUAL FOR MAINTENANCE
SPECIFICATIONS AND ADJUSTMENTS.



KIORTZ CORP. 

An Emission Control Label is located on the unit. (This is an EXAMPLE ONLY, information on label varies by engine FAMILY).

PRODUCT EMISSION DURABILITY

The 300 hour emission durability compliance period is the time span selected by the manufacturer certifying the engine emissions output meets applicable emissions regulations, provided that approved maintenance procedures are followed as listed in the Maintenance Section of this manual.

DESCRIPTION

PB-755H

Locate these safety decals on your unit. Make sure the decals are legible and that you understand and follow the instructions on them. If a decal cannot be read, a new one can be ordered from your ECHO dealer. See PARTS ORDERING instructions for specific information.

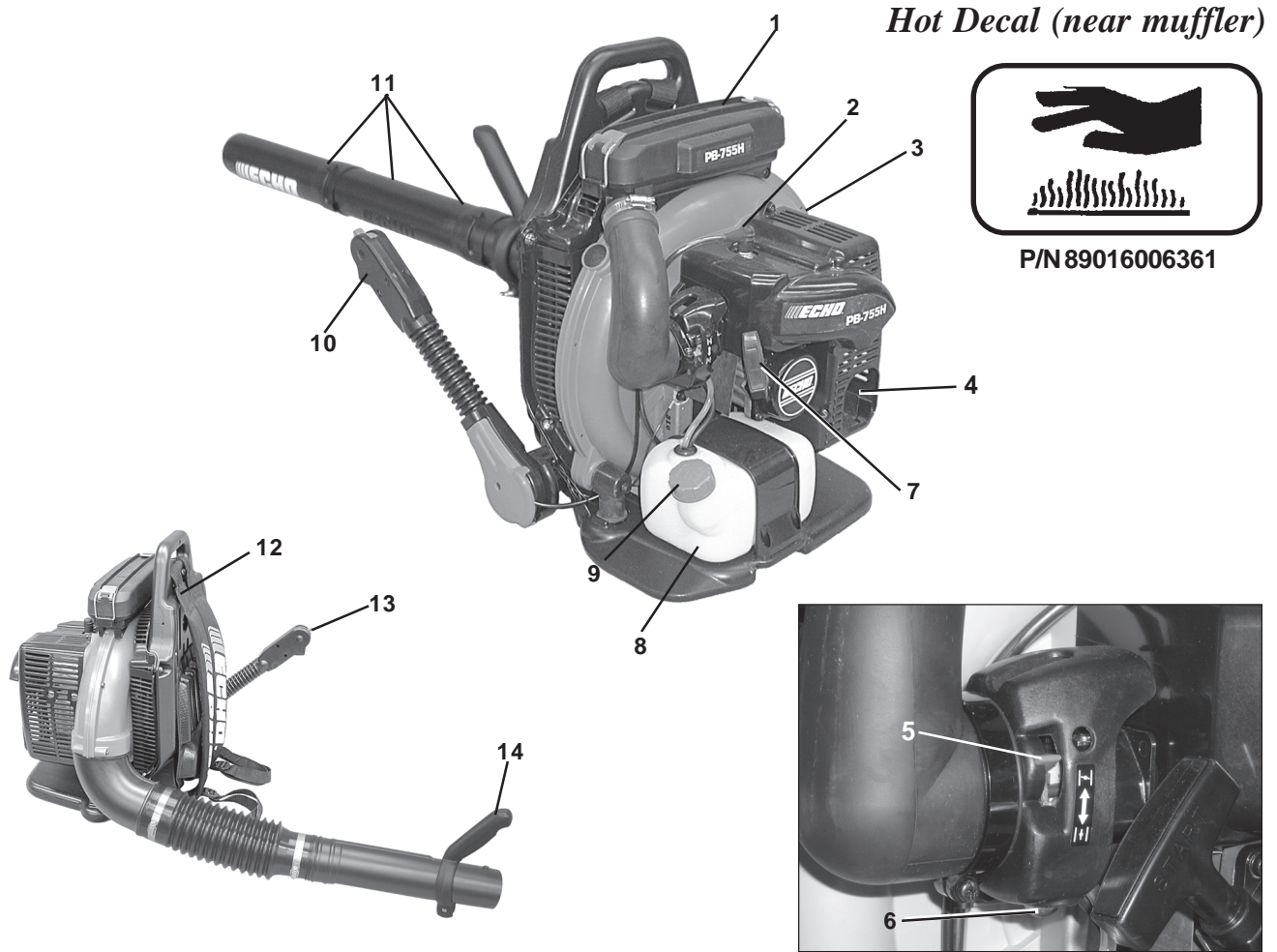



General Warning Decal (located on top of blower housing)



Sound Label (located on blower housing)



P/N X508000180

1. **AIR CLEANER** - Contains replaceable air filter element.
2. **SPARK PLUG** - Provides spark to ignite fuel mixture.
3. **SAFETY DECAL** - Lists important safety precautions.
4. **SPARK ARRESTOR - CATALYTIC MUFFLER/MUFFLER** - The muffler or catalytic muffler controls exhaust noise and emission. The spark arrestor screen prevents hot, glowing particles of carbon from leaving the muffler. Keep exhaust area clear of flammable debris.
5. **CHOKE** - Move lever up to "Cold Start" () starting position and for emergency stopping. Move lever down to Run position () .
6. **PURGE BULB** - Pumping purge bulb before starting engine draws fresh fuel from the fuel tank, purging air from the carburetor. Pump purge bulb until fuel is visible and flows freely in the clear fuel tank return line. Pump purge bulb an additional 4 or 5 times.
7. **RECOIL STARTER HANDLE** - Pull recoil handle slowly until starter engages, then quickly and firmly. When engine starts, return handle slowly. DO NOT let handle snap back or damage to unit will occur.
8. **FUEL TANK** - Contains fuel and fuel filter.
9. **FUEL TANK CAP** - Covers and seals fuel tank.
10. **HANDLE** - Rotates downward for throttle control access. Spring loaded for flexible operation.
11. **BLOWER PIPES** - Exclusive positive locking system.
12. **SHOULDER HARNESS** - Used to support unit on operator's back. The straps are adjustable.
13. **THROTTLE POSITION LEVER/STOP SWITCH** - Combination stop switch and variable speed throttle lever. When the lever is moved all the way forward the blower is at Wide Open Throttle (W.O.T.). When the lever is moved rearward to detent, the blower is at idle. When the lever is moved rearward past the idle detent the blower will stop.
14. **STICK HANDLE** - Provides comfortable grip for directing air flow.

PB-755T

Locate these safety decals on your unit. Make sure the decals are legible and that you understand and follow the instructions on them. If a decal cannot be read, a new one can be ordered from your ECHO dealer. See PARTS ORDERING instructions for specific information.

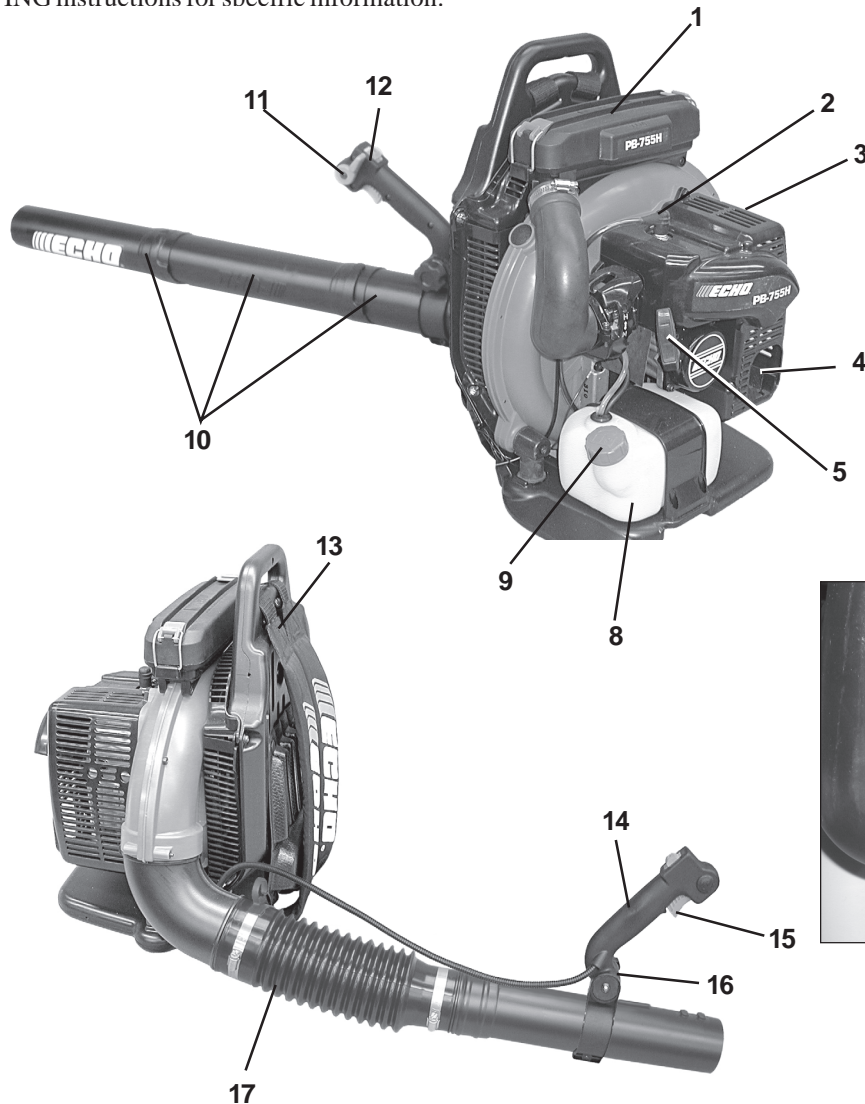

Hot Decal (near muffler)

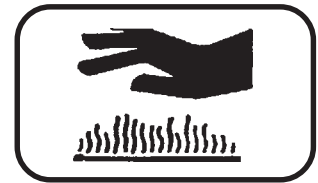

P/N 89016006361

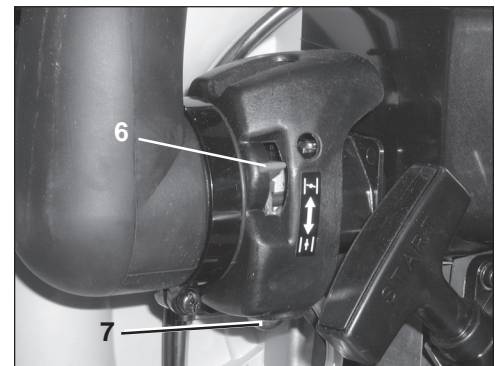

General Warning Decal (located on top of blower housing)





P/N 89016009461

Sound Label (located on blower housing)



P/N X508000180

1. **AIR CLEANER** - Contains replaceable air filter element.
2. **SPARK PLUG** - Provides spark to ignite fuel mixture.
3. **SAFETY DECAL** - Lists important safety precautions.
4. **SPARK ARRESTOR - CATALYTIC MUFFLER/MUFFLER** - The muffler or catalytic muffler controls exhaust noise and emission. The spark arrestor screen prevents hot, glowing particles of carbon from leaving the muffler. Keep exhaust area clear of flammable debris.
5. **RECOIL STARTER HANDLE** - Pull recoil handle slowly until starter engages, then quickly and firmly. When engine starts, return handle slowly. DO NOT let handle snap back or damage to unit will occur.
6. **CHOKE** - Move lever up to "Cold Start" () starting position and for emergency stopping. Move lever down to Run position () .
7. **PURGE BULB** - Pumping purge bulb before starting engine draws fresh fuel from the fuel tank, purging air from the carburetor. Pump purge bulb until fuel is visible and flows freely in the clear fuel tank return line. Pump purge bulb an additional 4 or 5 times.
8. **FUEL TANK** - Contains fuel and fuel filter.
9. **FUEL TANK CAP** - Covers and seals fuel tank.
10. **BLOWER PIPES** - Exclusive positive locking system.
11. **THROTTLE POSITION LEVER** - Pull back to increase engine speed. Friction washers maintain throttle lever setting.
12. **STOP SWITCH** - Slide switch mounted on top of handle. Move forward to run, back to stop.
13. **SHOULDER HARNESS** - Used to support unit on operator's back. The straps are adjustable.
14. **HANDLE** - Used by operator to direct and control air flow.
15. **THROTTLE TRIGGER** - Spring loaded to return to idle when released. During acceleration, press trigger gradually for best operating technique.
16. **LOCKING KNOB** - Allows operator to adjust handle position for optimum comfort and control.
17. **FLEXIBLE PIPE** - Allows for full range of movement.

CONTENTS

PB-755H

- ___ 1 - Power Head
- ___ 1 - Flex Pipe
- ___ 1 - Pipe w/swivel
- ___ 1 - Straight Pipe
- ___ 1 - Straight Pipe
- ___ 1 - Operator's Manual
- ___ 1 - Warranty Registration Card
- ___ 1 - ECHO Emissions and Warranty Statement
- ___ 1 - Plastic Bag
- ___ 2 - Clamps w/screws
- ___ 1 - Stick Handle
- ___ 1 - Bolt 6x45
- ___ 1 - Washer 6
- ___ 1 - Wing nut
- ___ 1 - Echo Power Blend™ 2-stroke oil sample

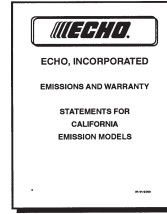
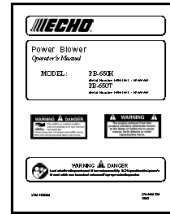

PB-755T

- ___ 1 - Power Head
- ___ 1 - Flex Pipe
- ___ 1 - Pipe w/swivel
- ___ 1 - Straight Pipe
- ___ 1 - Straight Pipe
- ___ 1 - Operator's Manual
- ___ 1 - Warranty Registration Card
- ___ 1 - ECHO Emissions and Warranty Statement
- ___ 1 - Plastic Bag
- ___ 2 - Clamps w/screws
- ___ 1 - Guide Loop
- ___ 1 - Echo Power Blend™ 2-stroke oil sample

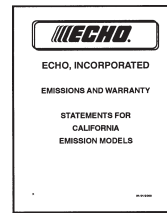
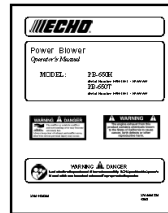

ASSEMBLY

PB-755H

WARNING DANGER

Never perform maintenance or assembly procedures with engine running or serious personal injury may result.

INSTALL BLOWER PIPES / STICK HANDLE

1. Assemble clamps (A) onto both ends of flexible pipe (B).
2. Assemble swivel pipe (C) into flexible pipe (B) and tighten clamp (A).
3. Assemble flexible pipe (B) to elbow (D) on blower and tighten clamp (A).

NOTE

A light lubricant may be used to ease assembly of flexible pipe to blower elbow.

4. Loosen wing nut (E) completely and open stick handle clamp.
5. Align notches (F) in handle clamp with tabs (G).
6. Slide stick handle onto swivel pipe (C). Stick handle should be angled away from operator.
7. Position stick handle (H) for comfortable operation, and tighten wing nut (E).
8. Assemble straight pipe (I) onto swivel pipe (C), until you feel light resistance. Do not force connection. Hold swivel pipe and turn straight pipe clockwise, engaging positive locking channels, until connection is firm. Do not force connection.
9. Assemble straight pipe with decal (J) to straight pipe (I) as in step 8.

NOTE

Blower use will eventually loosen pipe connections. Exclusive positive locking system allows pipes to be tightened. If loosening occurs, remove two straight pipes and install according to instructions 8 & 9.

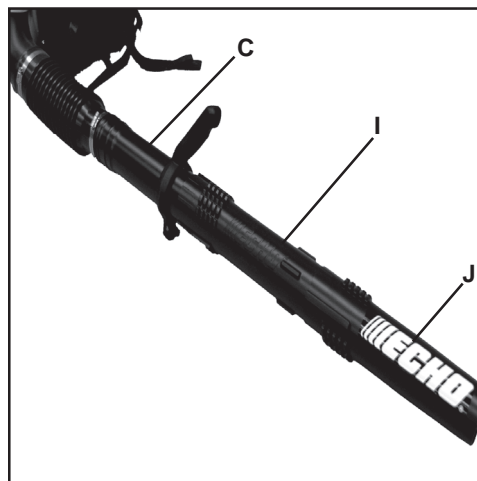
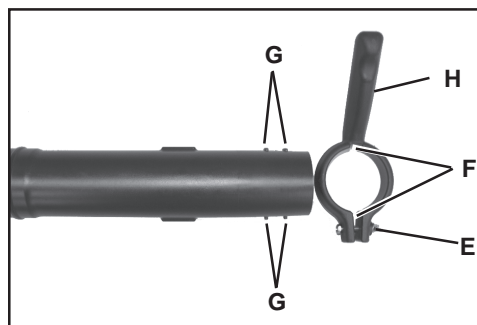
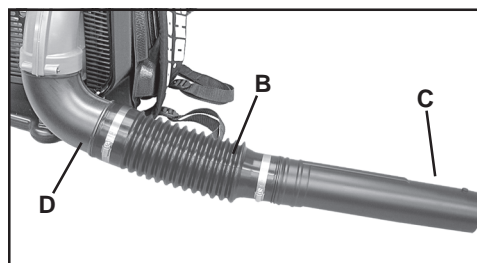
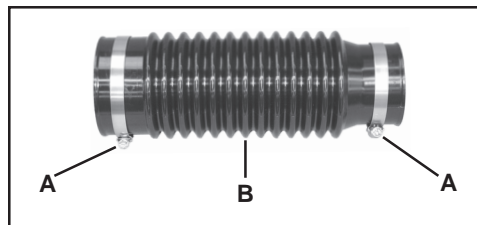

PB-755T

WARNING  **DANGER**

Never perform maintenance or assembly procedures with engine running or serious personal injury may result.

INSTALL BLOWER PIPES

1. Place guide loop (H) across elbow clamp, and turn until clips fully engage clamp band.
2. Assemble clamps (A) onto both ends of flexible pipe (B).

NOTE

Clamp with cable guide loop (H) fits elbow end of flexible pipe.

3. Assemble swivel pipe (C) into flexible pipe (B).

NOTE

Assure throttle cable is not twisted before installing handle (F).

4. Position cable between the elbow (D) and frame and along the top of the flexible pipe. Remove clamp screw (E) on handle (F). Align notch in handle with tabs (G). Spread clamp and install onto swivel pipe (C) past long ridges in pipe.
5. Assemble flexible pipe (B) to elbow (D) on blower and tighten clamps (A). Position guide loop (H) on inside (blower side) of flexible tube.

NOTE

A light lubricant may be used to ease assembly of flexible pipe to blower elbow.

6. Clip throttle cable into throttle cable guide loop (H).
7. Move handle (F) to desired position. Tighten knob (I) hand tight. Install and tighten clamp screw (E).
8. Assemble straight pipe (J) onto swivel pipe (C), until you feel light resistance. Do not force connection. Hold swivel pipe and turn straight pipe clockwise, engaging positive locking channels, until connection is firm. Do not force connection.
9. Assemble straight pipe with decal (K) to straight pipe (J) as in step 8.

NOTE

Blower use will eventually loosen pipe connections. Exclusive positive locking system allows pipes to be tightened. If loosening occurs, remove two straight pipes and install according to instructions 8 & 9.

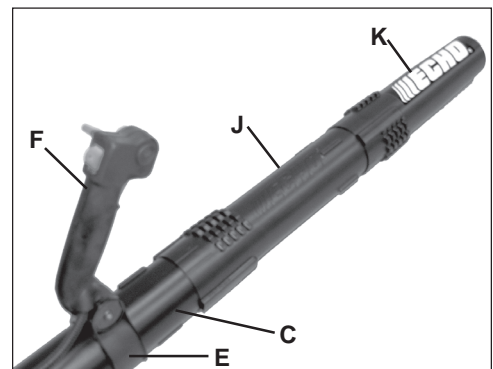
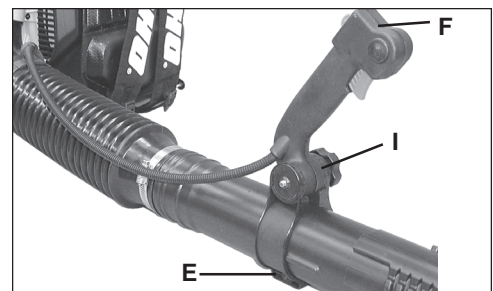
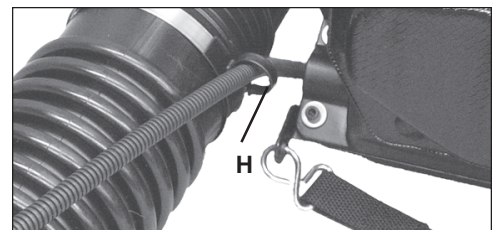
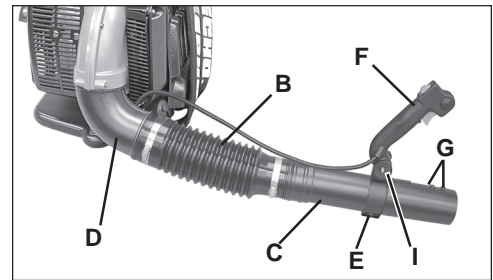
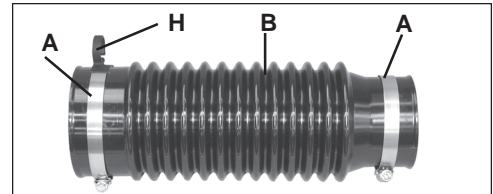
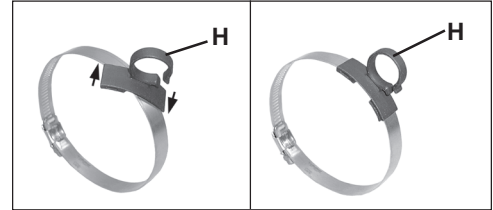

OPERATION

NOTICE: Use of unmixed, improperly mixed, or fuel older than 90 days, (stale fuel), may cause hard starting, poor performance, or severe engine damage and void the product warranty. Read and follow instructions in the Storage section of this manual.

FUEL

Fuel Requirements

Gasoline - Use 89 Octane [R+M/2] (mid grade or higher) gasoline known to be good quality. Gasoline may contain up to 15% MTBE (methyl tertiary-butyl ether). Gasohol containing methyl (wood) alcohol is **NOT** approved.

Two Stroke Oil - A two-stroke engine oil meeting ISO-L-EGD (ISO/CD 13738) and J.A.S.O. FC Standards must be used. Echo brand premium Power Blend™ Universal 2-Stroke Oil meets these standards. Engine problems due to inadequate lubrication caused by failure to use an ISO-L-EGD and J.A.S.O. FC certified oil, such as Echo premium Power Blend™, will void the two-stroke engine warranty. (Emission related parts only are covered for two years, regardless of two-stroke oil used, per the statement listed in the Emission Defect Warranty Explanation.)

IMPORTANT

Echo premium Power Blend™ Universal 2-Stroke Oil may be mixed at 50:1 ratio for application in all Echo engines sold in the past regardless of ratio specified in those manuals.

Handling Fuel

WARNING DANGER

Fuel is VERY flammable. Use extreme care when mixing, storing or handling or serious personal injury may result.

- Use an approved fuel container.
- DO NOT smoke near fuel.
- DO NOT allow flames or sparks near fuel.
- Fuel tanks/cans may be under pressure. Always loosen fuel caps slowly allowing pressure to equalize.
- NEVER refuel a unit when the engine is HOT or RUNNING!
- DO NOT fill fuel tanks indoors. ALWAYS fill fuel tanks outdoors over bare ground.
- DO NOT overfill fuel tank. Wipe up spills immediately.
- Securely tighten fuel tank cap and close fuel container after refueling.
- Inspect for fuel leakage. If fuel leakage is found, do not start or operate unit until leakage is repaired.
- Move at least 3m (10 ft.) from refueling location before starting the engine.

Fuel to Oil Mix - 50:1 Ratio

U.S.		METRIC	
GAS	OIL	GAS	OIL
Gallons	Fl. oz.	Liter	cc.
1	2.6	4	80
2	5.2	8	160
5	13	20	400

Mixing Instructions

1. Fill an approved fuel container with half of the required amount of gasoline.
2. Add the proper amount of 2-stroke oil to gasoline.
3. Close container and shake to mix oil with gasoline.
4. Add remaining gasoline, close fuel container, and remix.

IMPORTANT

Spilled fuel is a leading cause of hydrocarbon emissions. Some states may require the use of automatic fuel shut-off containers to reduce fuel spillage.

After use

- DO NOT store a unit with fuel in its tank. Leaks can occur. Return unused fuel to an approved fuel storage container.

Storage - Fuel storage laws vary by locality. Contact your local government for the laws affecting your area. As a precaution, store fuel in an approved, airtight container. Store in a well-ventilated, unoccupied building, away from sparks and flames.

IMPORTANT

Stored fuel ages. Do not mix more fuel than you expect to use in thirty (30) days, ninety (90) days when a fuel stabilizer is added.

IMPORTANT

Stored two-stroke fuel may separate. ALWAYS shake fuel container thoroughly before each use.

STARTING COLD ENGINE

- Recoil starter: Use short pulls - only 1/2-2/3 of rope length for starting. Do not allow the rope to snap back in. Always hold the unit firmly.

PB-755H

1. *Throttle Lever*
Move throttle lever (A) to IDLE DETENT position.

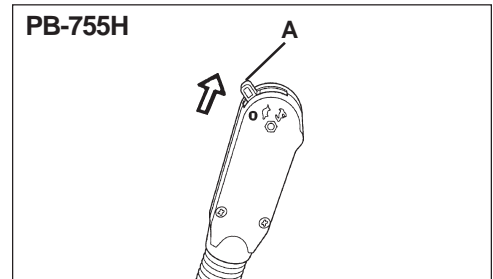

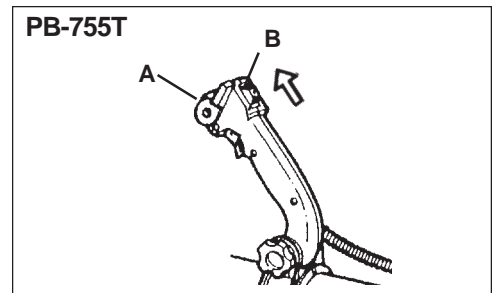

PB-755T

1. *Throttle Lever/Stop Switch*
Move throttle lever (A) forward to idle position. Slide stop switch (B) forward to run position.



PB-755H, PB-755T

2. *Choke*
Move choke (C) up to "Cold Start" position ().
3. *Purge Bulb*
Pump purge bulb (D) until fuel is visible and flows freely in the clear fuel tank return line. Pump bulb an additional 4 or 5 times.
4. *Recoil Starter*
Pull recoil starter handle (E) until engine fires (5 or 6 pulls maximum).
5. *Choke*
Move choke (C) down to run position (), and if necessary, restart engine.

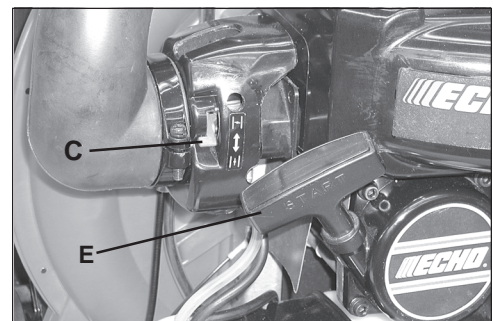
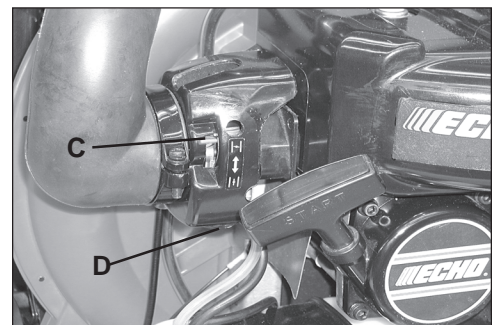

NOTE

If engine does not start after 5 pulls, move choke to "Cold Start" position, and repeat steps 4 & 5.

NOTE

Allow engine to warm up before use.

STARTING WARM ENGINE

PB-755H

1. *Throttle Lever*
Move throttle lever (A) to IDLE DETENT position.

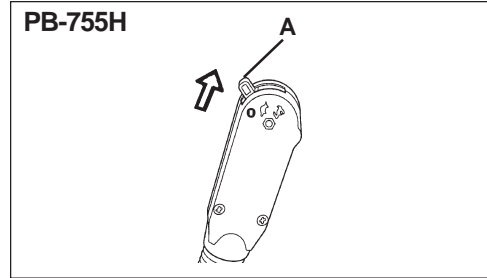

PB-755T

1. *Throttle Lever/Stop Switch*
Move throttle lever (A) forward to idle position. Slide stop switch (B) forward to run position.

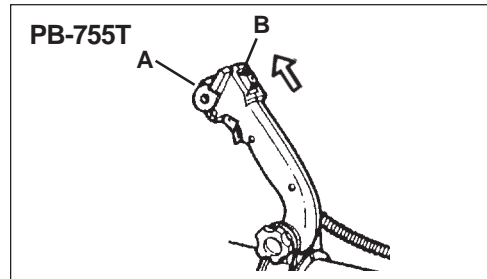

PB-755H, PB-755T

2. *Recoil Starter*
Pull recoil starter handle (E) and engine should start. Do not use choke (C).

NOTE

If engine does not start after 5 pulls, use cold start procedures.

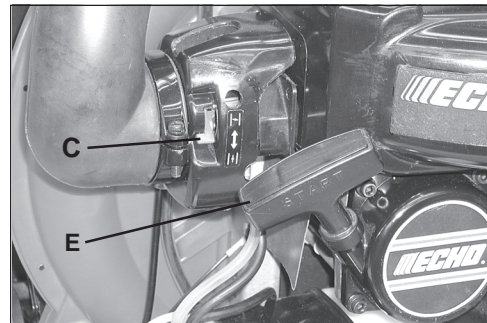

STOPPING ENGINE

PB-755H

1. *Throttle Lever*
Move throttle lever (A) to idle detent position and allow engine to return to idle before shutting off engine.
2. Move throttle lever (A) to "O" (Stop) position.

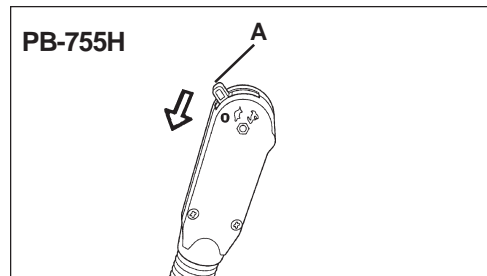

PB-755T

1. *Throttle Trigger/Throttle Position Lever*
Release throttle trigger (C). Move throttle position lever (A) forward to idle position and allow engine to return to idle before shutting engine off.
2. *Stop Switch*
Slide stop switch (B) to Stop position.

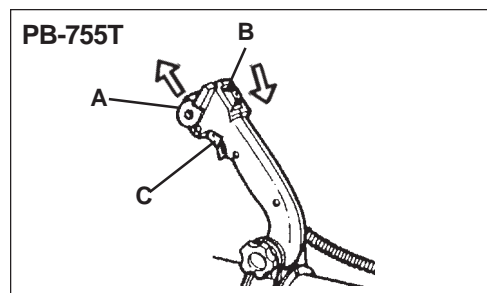

WARNING DANGER

If engine does not stop when stop switch is moved to STOP position, close choke - COLD START position - to stall engine. Have your ECHO dealer repair stop switch before using blower again.

OPERATING BLOWER

WARNING **DANGER**

Always wear safety glasses, hearing protection, a face filter mask and take all safety precautions or serious personal injury may result.

Do not point the blower pipe in the direction of people or pets.

Read the Safety Section on pages 4 - 6 carefully.

IMPORTANT

To avoid engine damage due to over-revving, do not block blower pipe opening.

1. Use only during appropriate hours.
2. Allow the engine to warm up at a fast idle for a few minutes.
3. **PB-755H**
Set engine speed with throttle lever (A).
3. **PB-755T**
Control engine speed with throttle trigger (C), or throttle position lever (A). Rotate throttle position lever forward for lower speed, back for higher speed.
4. Use lower speed to blow dry leaves from walks, patios and drives.
5. Additional speed may be necessary to clean grass and leaves from a lawn or flower bed.
6. Higher speed may be necessary to move gravel, dirt, snow, bottles or cans from a driveway, street, parking lot or stadium.

NOTE

Never use a higher speed setting than necessary to perform a task. Remember, the higher the engine speed, the louder the blower noise. Minimize dust by using blower at lower speeds and by dampening material with water/mist when necessary. Keep debris on your property.

Be Smart - be a good neighbor.

PB-755H

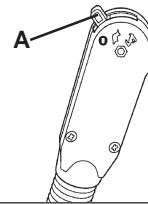

PB-755T

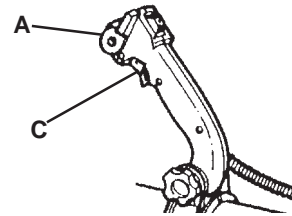

MAINTENANCE

Your ECHO blower is designed to provide many hours of trouble free service. Regular scheduled maintenance will help your blower achieve that goal. If you are unsure or are not equipped with the necessary tools, you may want to take your unit to an ECHO Service Dealer for maintenance. To help you decide whether you want to DO-IT-YOURSELF or have the ECHO Dealer do it, each maintenance task has been graded. If task is not listed, see your ECHO Dealer for repairs.

SKILL LEVELS

- Level 1** = Easy to do. Most required tools come with unit.
- Level 2** = Moderate difficulty. Some specialized tools may be required.
- Level 3** = Experience required. Specialized tools are required. Echo recommends the unit be returned to your Echo Dealer for servicing.

ECHO offers **REPOWER™** Maintenance Kits and Parts to make your maintenance job easier. Just below each task heading are listed the various part numbers required for that task. See your ECHO dealer for these parts.

MAINTENANCE INTERVALS

COMPONENT/ SYSTEM	MAINTENANCE PROCEDURE	REQ'D SKILL LEVEL	DAILY OR BEFORE USE	EVERY REFUEL	3 MONTHS OR 90 HOURS	6 MONTHS OR 270 HOURS	YEARLY
Recommended Echo Dealer Maintenance Procedures							
Cylinder Exhaust Port	Inspect/Clean/Decarbon	3			I / C		
Do-It-Yourself Maintenance Procedures							
Air Filter	Inspect/Clean/Replace	1	I / C		R*		
Choke	Inspect/Clean	2	I / C				
Fuel Filter	Inspect/Replace	1			I		R*
Fuel System, Leaks	Inspect/Replace	1	I	I / R*			
Cooling System	Inspect/Clean	2	I / C				
Muffler Spark Arrestor	Inspect/Replace	2			I / R*		
Recoil Starter Rope	Inspect/Clean	1	I / C				I / R*
Spark Plug	Inspect/Clean	2			I / C	R*	
Screws/Nuts/Bolts	Inspect/Tighten/Replace	1	I / R*				

MAINTENANCE PROCEDURE LETTER CODES: I = INSPECT, R = REPLACE, C = CLEAN

IMPORTANT NOTE - Time intervals shown are maximum. Actual use and your experience will determine the frequency of required maintenance.

MAINTENANCE PROCEDURE NOTES:

* All recommendations to replace are based on the finding of damage or wear during inspection.

AIR FILTER

Level 1.

Tools required: 25 - 50mm (1 - 2 in.) cleaning brush

Parts required: Tune Up Kit P/N 90071C

NOTE

Always brush dirt and debris away from air cleaner area prior to cleaning air filter.

1. Brush dirt off air cleaner area. Keep dirt away from engine and air intake grid.
2. Remove air filter cover. Brush dirt from inside cover and away from edges of air filter.
3. Check air filter seal for tight fit with air filter case.
4. Remove air filter from case. Use care to prevent dirt and debris from falling into air filter case.
5. Inspect filter element and seal. Replace filter if any of these problems are present:
 - Air filter seal does not fit tightly against case
 - Air filter seal is distorted, worn, or damaged
 - Air filter element has holes or other damage
 - Air filter element is saturated with dirt
 - Air filter element is soaked with fuel mix
6. If air filter is in good condition and can be cleaned and reused, lightly brush debris from air filter element, or blow filter element clean using low pressure (40 psi or less) compressed air directed at inside of filter.

IMPORTANT

When using compressed air, always direct air stream at inside surface of filter so dust and debris will be blown out of filter. Keep air nozzle 6 - 8 inches away from filter to prevent damage to filter.

7. Install air filter in case, and replace cover.

NOTICE

Actual replacement interval for air filter depends on operating conditions. Operation in dustier applications requires more frequent cleaning and replacement. Continued operation with a damaged or excessively dirty filter will allow dirt and debris to enter engine, and result in poor performance, rapid engine wear, and premature engine failure.

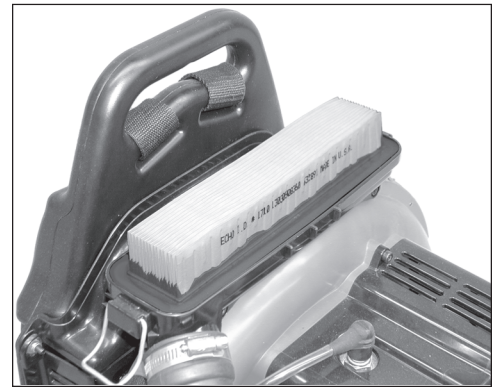

FUEL FILTER

Level 1.

Tools required: 200 - 250 mm (8 - 10 in.) length of wire with one end bent into a hook, clean rag, funnel, and an approved fuel container

Parts required: Repower™ Tune Up Kit P/N 90071

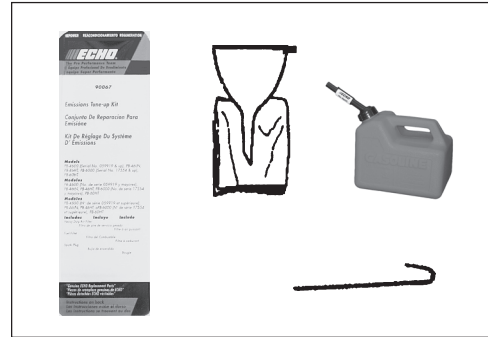

WARNING DANGER

Fuel is **VERY** flammable. Use extreme care when mixing, storing or handling.

1. Use a clean rag to remove loose dirt from around fuel cap and empty fuel tank.
2. Use the “fuel line hook” to pull the fuel line and filter from the tank.
3. Remove the filter from the line and install the new filter.



SPARK PLUG

Level 1.

Tools required: 19mm Spark Plug deep socket, Feeler gauge

Parts Required: Repower™ Tune Up Kit P/N 90071

IMPORTANT

Use only NGK BPM-8Y spark plug (BPMR-8Y in Canada) otherwise severe engine damage may occur.

1. Remove spark plug, and check for fouling, worn and rounded center electrode.
2. Clean the plug or replace with a new one. DO NOT sand blast to clean. Remaining sand will damage engine.
3. Adjust spark plug gap by bending outer electrode.
4. Tighten spark plug to 150-170 kg/cm (130-150 in. lb.).

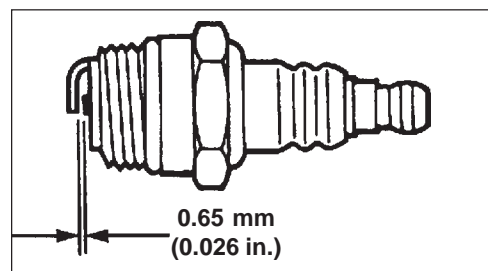
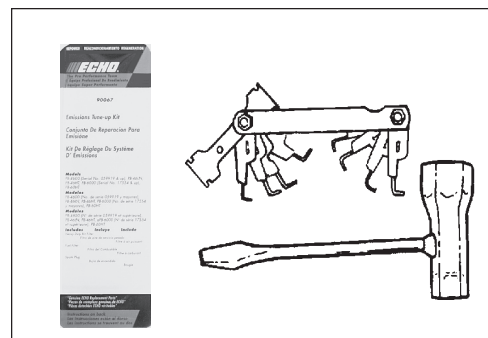

COOLING SYSTEM

Level 2.

Tools required: 25 - 50mm (1 - 2 in.) cleaning brush, Cross Head Screwdriver

Parts Required: None, if you are careful.

IMPORTANT

To maintain proper engine operating temperatures, cooling air must pass freely through the cylinder fin area. This flow of air carries combustion heat away from the engine.

Overheating and engine seizure can occur when:

- Air intakes are blocked, preventing cooling air from reaching the cylinder.
- Dust and grass build up on the outside of the cylinder. This build up insulates the engine and prevents the heat from leaving.

Removal of cooling passage blockages or cleaning of cooling fins is considered "Normal Maintenance." Any failure attributed to lack of maintenance is not warranted.

Cleaning Grill

1. Remove accumulated debris from intake grill between backpack frame and blower housing.

Cleaning Cylinder Fins

1. Remove spark plug and engine cover (four screws), pull cover away from engine.
2. Clean cylinder fins (A) to allow cooling air to pass freely.
3. Install engine cover and spark plug.

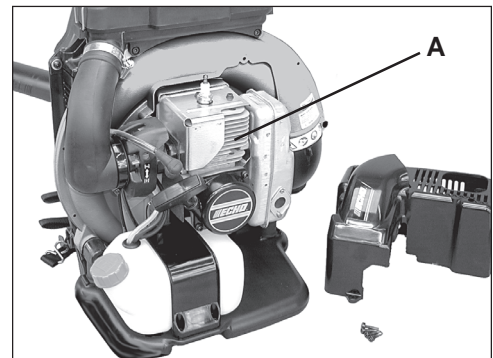
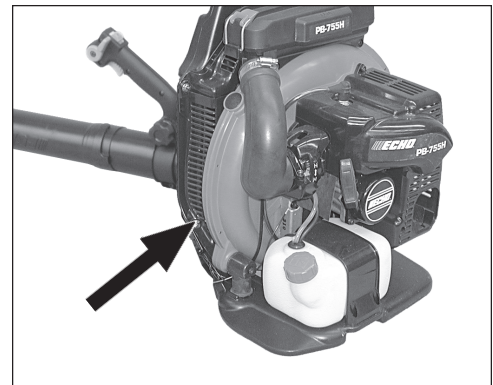
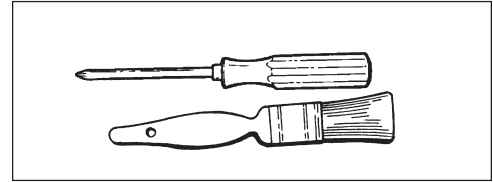

EXHAUST SYSTEM

Spark Arrestor Screen

Level 2.

Tools required: Cross Head Screwdriver

Parts Required: Spark arrestor screen, Gaskets

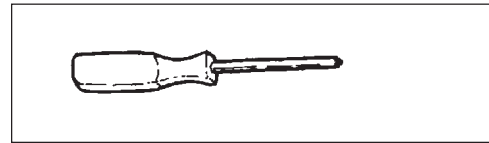

WARNING **DANGER**

Do not perform maintenance on engine or muffler until engine and muffler are completely cool, otherwise serious personal injury may result.

IMPORTANT

Carbon deposits in muffler will cause a drop in engine output and overheating. Spark arrestor screen must be checked periodically.

1. Remove spark plug and engine cover (four screws).
2. Remove spark arrestor covers (A), gaskets (B), and spark arrestor screen (C) from muffler. Replace screen if plugged with carbon deposits.

NOTE

When cleaning carbon deposit, be careful not to damage the catalytic element inside muffler.

3. Install spark arrestor screen and cover.
4. Install spark plug and engine cover.

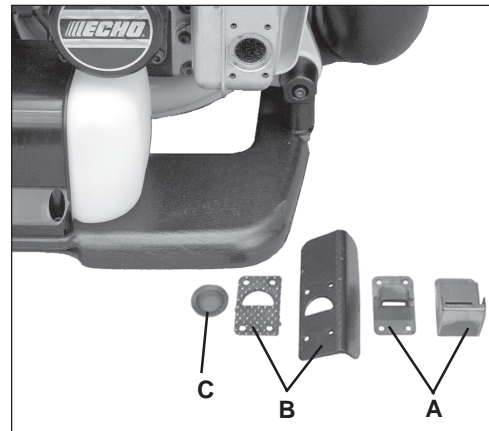

Cylinder Exhaust Port

Level 3.

IMPORTANT

The cylinder exhaust port must be inspected and cleaned of excess carbon every 3 months or 90 hours of operation in order to maintain this engine within the emissions durability period. ECHO strongly recommends that you return your unit to your ECHO dealer for this important maintenance service.

CARBURETOR ADJUSTMENT

Engine Break-In

New engines must be operated a minimum duration of two tanks of fuel break-in before carburetor adjustments can be made. During the break-in period your engine performance will increase and exhaust emissions will stabilize. Idle speed can be adjusted as required.

High Altitude Adjustment

High altitude adjustment is not required for proper operation of this engine.

Level 2.

Tools required: Screwdriver, tachometer (Echo P/N 99051130017)

Parts required: None.

NOTE

Do not adjust carburetor unless necessary. If you have difficulty, see your ECHO dealer.

Before Adjustment

Check that:

- Air filter is clean and properly installed.
 - Spark arrestor screen is free of carbon.
 - Blower pipes are installed.
1. Start engine, run at idle for one minute.
 2. Complete warm up by running at full throttle for 5 minutes, operating choke twice to clear air from carburetor chambers.
 3. Check idle speed and reset if necessary. If a tachometer is available, idle speed screw (A) should be set to the specifications found on Page 26 "Specifications" of this manual. Turn idle screw (A) clockwise to increase idle speed; counter clockwise to decrease idle speed.
 4. Use a tachometer to adjust idle speed to specifications found on page 26.

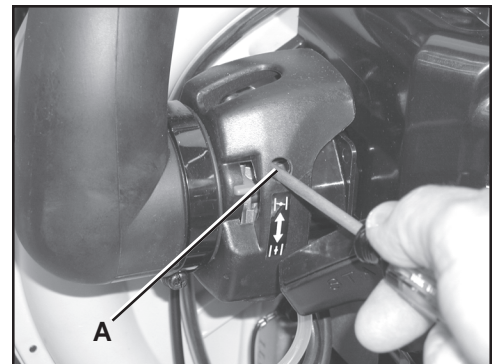
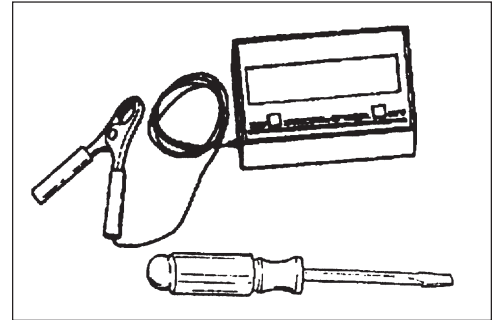

TROUBLESHOOTING

TROUBLESHOOTING CHART

Problem	Check	Status	Cause	Remedy
Engine cranks - starts hard/ doesn't start	Fuel at carburetor	No fuel at carburetor	Fuel strainer clogged Fuel line clogged Carburetor	Clean or replace Clean or replace See your Echo dealer
	Fuel at cylinder	No fuel at cylinder	Carburetor	See your Echo dealer
		Muffler wet with fuel	Fuel Mixture too rich	Open choke Clean/replace air filter Adjust carburetor See your Echo dealer
	Spark at end of plug wire	No spark	Stop switch off Electrical problem Interlock switch	Turn switch to ON See your Echo dealer See your Echo dealer
	Spark at plug	No spark	Spark gap incorrect Covered with carbon Fouled with fuel Plug defective	Adjust to .65mm (0.026 in.) Clean or replace Clean or replace Replace plug
Engine runs, but dies or does not accelerate properly	Air filter	Air filter dirty	Normal wear	Clean or replace
	Fuel filter	Fuel filter dirty	Contaminants/residues in fuel	Replace
	Fuel vent	Fuel vent plugged	Contaminants/residues in fuel	Clean or replace
	Spark Plug	Plug dirty/worn	Normal wear	Clean and adjust or replace
	Carburetor	Improper adjustment	Vibration	Adjust
	Cooling System	Cooling system dirty/plugged	Extended operation in dirty/dusty locations	Clean
	Spark Arrestor Screen	Spark arrestor screen plugged	Normal wear	Replace
Engine does not crank	N/A	N/A	Internal engine problem	See your Echo dealer
Engine runs, blower doesn't work or is weak/uneven	Blower pipe	Pipe clogged	Build-up of debris	Unclog
		Pipe loose	Vibration	Tighten
		Pipe damaged	Wear/Misuse	Replace

WARNING DANGER

Fuel vapors are **extremely** flammable and may cause fire and/or explosion. **Never** test for ignition spark by grounding spark plug near cylinder plug hole, otherwise serious personal injury may result.

STORAGE

WARNING  **DANGER**

During operation the muffler or catalytic muffler and surrounding cover become hot. Always keep exhaust area clear of flammable debris during transportation or when storing, otherwise serious property damage or personal injury may result.

Long Term Storage (Over 30 Days)

Do not store your unit for a prolonged period of time (30 days or longer) without performing protective storage maintenance which includes the following:

1. Store unit in a dry, dust free place, out of the reach of children.
2. Place the stop switch in the "STOP" position.
3. Remove accumulation of grease, oil, dirt and debris from exterior of unit.
4. Perform all periodic lubrication and services that are required.
5. Tighten all screws and nuts.
6. **Drain** the fuel tank **completely** and pull the recoil starter handle several times to remove fuel from the carburetor.
7. Remove the spark plug and pour 7cc (1/4 oz.) of fresh, clean ECHO 2-stroke engine oil into the cylinder through the spark plug hole.
 - A. Place a clean cloth over the spark plug hole.
 - B. Pull the recoil starter handle 2-3 times to distribute the oil inside the engine.
 - C. Observe the piston location through the spark plug hole. Pull the recoil handle slowly until the piston reaches the top of its travel and leave it there.
8. Install the spark plug (do not connect ignition cable).
9. Remove blower pipe assembly from unit.

WARNING  **DANGER**

Do not store in enclosure where fuel fumes may accumulate or reach an open flame or spark.

SPECIFICATIONS

MODEL	PB-755H, PB-755T
Length	375 mm (14.8 in.)
Width	485 mm (19 in.)
Height	527 mm (20.8 in.)
Weight (dry) (PB-755H)	11.8 kg (26.2 lb.)
Weight (dry) (PB-755T)	11.8 kg (26.2 lb.)
Engine Type	Air cooled, two-stroke, single cylinder gasoline engine
Displacement	63.3 cc (3.86 cu. in.)
Bore	48.0 mm (1.89 in.)
Stroke	35.0 mm (1.38 in.)
Carburetor	Walbro w/primer bulb
Ignition System	Flywheel Magneto, capacitor discharge ignition type
Spark Plug	NGKBPM-8Y Gap 0.65 mm (0.026 in.)
Exhaust System	Spark Arrestor Muffler w/catalyst
Fuel	Mixed (Gasoline and Two-stroke Oil)
Fuel/Oil Ratio	50:1 two-stroke air cooled engine oil
Gasoline	89 Octane unleaded. DO NOT use fuel containing methyl alcohol, more than 10% ethyl alcohol or 15% MTBE.
Oil	Power Blend™ Premium Universal 2-Stroke Oil
Fuel Tank Capacity	2.0 lit. (67.7 US fl. oz.)
Recoil Starter System	Automatic Recoil Starter Centrifugal Type
Idle Speed	2400 - 3200 (RPM)
Wide Open Throttle Speed	6800 - 7300 (RPM)
Maximum Air Speed (Measured at pipe end)	329.9 KM/H (205 mph)
Average Air Volume (Measured at pipe end)	17.6 m ³ /min. (620 cu. ft./min.)
Sound Level at 50 ft. dB(A) scale per ANSI B175.2 ----	74 dB(A)

NOTES

SERVICING INFORMATION

PARTS/SERIAL NUMBER

Genuine ECHO Parts and ECHO REPOWER™ Parts and Assemblies for your ECHO products are available only from an Authorized ECHO Dealer. When you do need to buy parts **always** have the Model Number and Serial Number of the unit with you. You can find these numbers on the engine housing. For future reference, write them in the space provided below.

Model No. _____ SN. _____

SERVICE

Service of this product during the warranty period must be performed by an Authorized ECHO Service Dealer. For the name and address of the Authorized ECHO Service Dealer nearest you, ask your retailer or call: 1-800-432-ECHO (3246). Dealer information is also available on our Web Site. When presenting your unit for Warranty service/repairs, proof of purchase is required.

ECHO CONSUMER PRODUCT SUPPORT

If you require assistance or have questions concerning the application, operation or maintenance of this product you may call the ECHO Consumer Product Support Department at 1-800-673-1558 from 8:30 am to 4:30 pm (Central Standard Time) Monday through Friday. Before calling, please know the model and serial number of your unit to help your Consumer Product Support Representative.

WARRANTY REGISTRATION

You may register your Echo equipment using the warranty registration card or register on-line at www.echo-usa.com. Registering provides a direct link between you and ECHO if we find it necessary to contact you.

ADDITIONAL OR REPLACEMENT MANUALS

Safety Manuals in English/Spanish or English/French are available, free of charge, from your ECHO dealer or at www.echo-usa.com.

Operator's and Parts Manuals are available by:

- Downloading free from www.echo-usa.com
- Purchasing from your Echo Dealer.
- Manuals are available by sending a written request stating the model number and serial number of your Echo unit, part number of the manual, your name and address, and mail to the address below.

Safety Videos are available from your Echo dealer. A \$5.00 shipping charge will be required for each video.

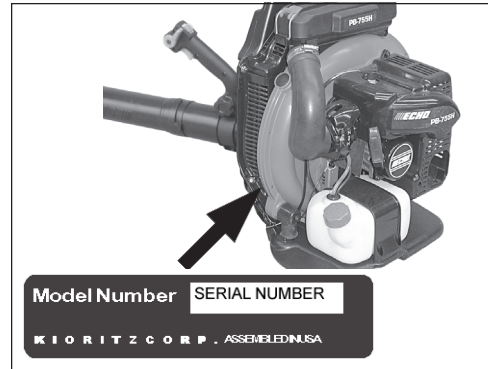

DEALER?

Call
1-800-432-ECHO
or
www.echo-usa.com

CONSUMER PRODUCT SUPPORT

1-800-673-1558
8:30 - 4:30 Mon - Fri C.S.T.



ECHO
ECHO, INCORPORATED
400 OAKWOOD ROAD
LAKE ZURICH, IL 60047
www.echo-usa.com

06001001/06999999