



Accessories for ECHO products can be found at:
Los accesorios para los productos ECHO se pueden encontrar en:
<http://www.echo-usa.com/Products/Accessories>

PARTS CATALOG
LISTA DE PIEZAS

EGi-3600LN
Generator

EGi-3600LN Generador



212 cc

SERIAL NUMBER
NÚMERO DE SERIE

EGi-200268- A0000001 - 200628- A9999999

ECHO Incorporated

400 Oakwood Road, Lake Zurich, Illinois 60047

WWW.ECHO-USA.COM

©2023 ECHO Incorporated. All Rights Reserved

P/N 99922205612
REVISED 04/06/23

Engine	3	Housing Base, Inverter, and Battery	24
Motor		Base de carcasa, inversor y batería	
Crankcase Components	4	Housing Base, Inverter, and Battery	25
Componentes del Cárter		Base de carcasa, inversor y batería	
Crankcase Components	5	Muffler Covers	26
Componentes del Cárter		Cubiertas de silenciador	
Crankcase Cover	6		
Tapa del cárter			
Cylinder Head Components	7		
Componentes del culata			
Crankshaft Components	8		
Componentes del cigüeñal			
Connecting Rod, Piston and Ring Set	9		
Conjunto de biela, pistón y anillo			
Valve Train	10		
Tren de Válvulas			
Recoil Starter	11		
Arrancador Autorretráctil			
Carburetor	12		
Carburador			
Ignition	14		
Encendido			
Air Filter	15		
Filtro de aire			
Exhaust	16		
Escape			
Fuel System	17		
Sistema de Combustible			
Frame	18		
Cuadro			
Control Panel Assembly	20		
Panel de Control			
Control Panel Assembly	21		
Panel de Control			
Handle	22		
Maneja			
Covers	23		
Cubiertas			



NO.	PART NUMBER	QTY.	DESCRIPTION	DESCRIPCIÓN
1	YH602000060	1	ASSY., ENGINE	ASSY., MOTOR

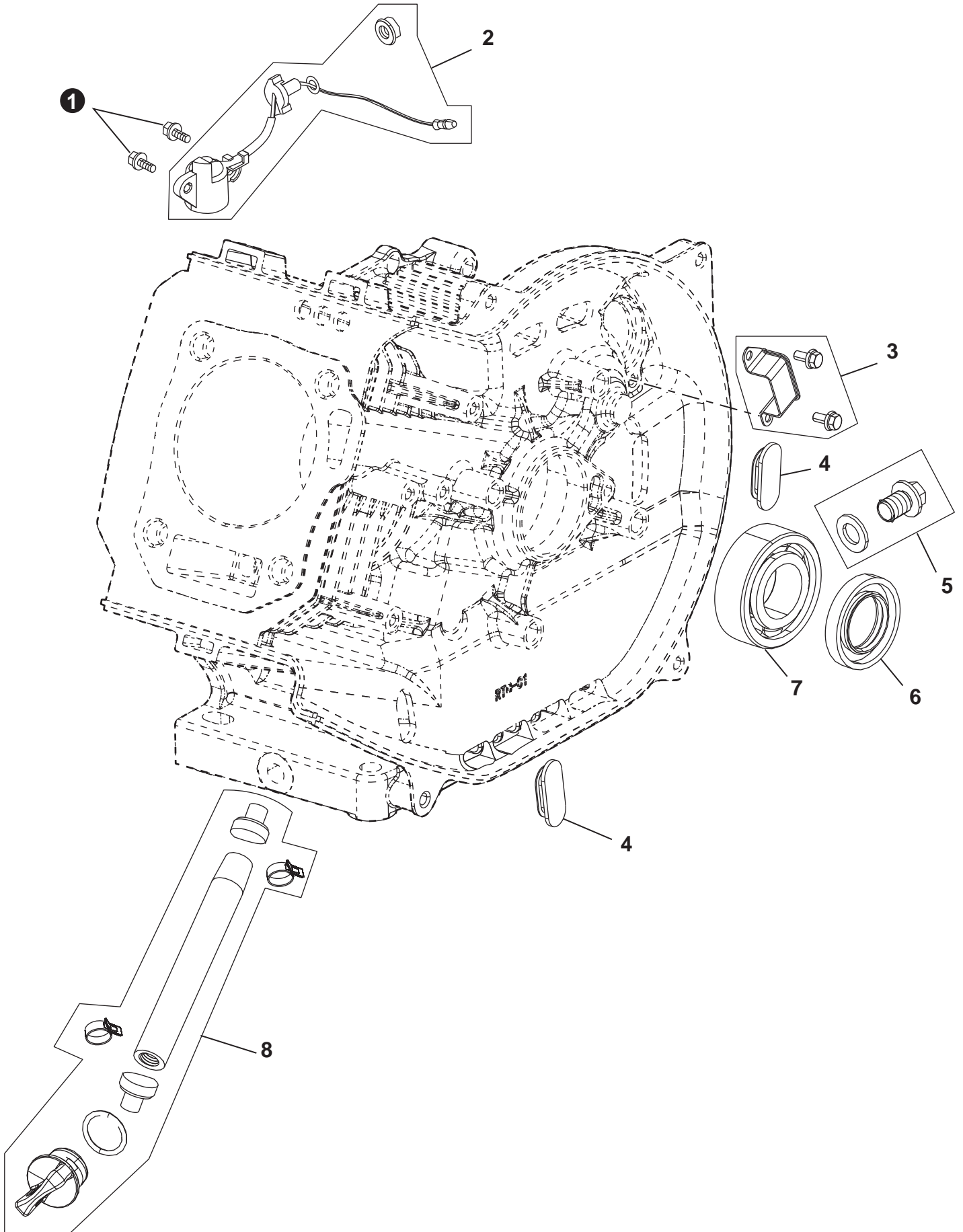

NO.	PART NUMBER	QTY.	DESCRIPTION	DESCRIPCIÓN
1	YH435000190	2	BOLT	TORNILLO
2	YH327000020	1	SENSOR, ENGINE OIL	SENSOR, ACEITE DE MOTOR
3	YH452000700	1	CLAMP, LEAD WIRE	ABRAZADERA, ALAMBRE DE PLOMO
4	YH468000510	2	PLUG, END	ENCHUFE, FIN
5	YH468000270	1	PLUG, OIL DRAIN	ENCHUFE, DRENAJE DE ACEITE
6	YH468000520	1	SEAL, OIL	ACEITE DE FOCA
7	YH453000150	1	BEARING, CRANKSHAFT	RODAMIENTO, CIGÜEÑAL
8	YH468000530	1	ASSY., OIL DRAIN TUBE	CONJUNTO., TUBO DE DRENAJE DE ACEITE

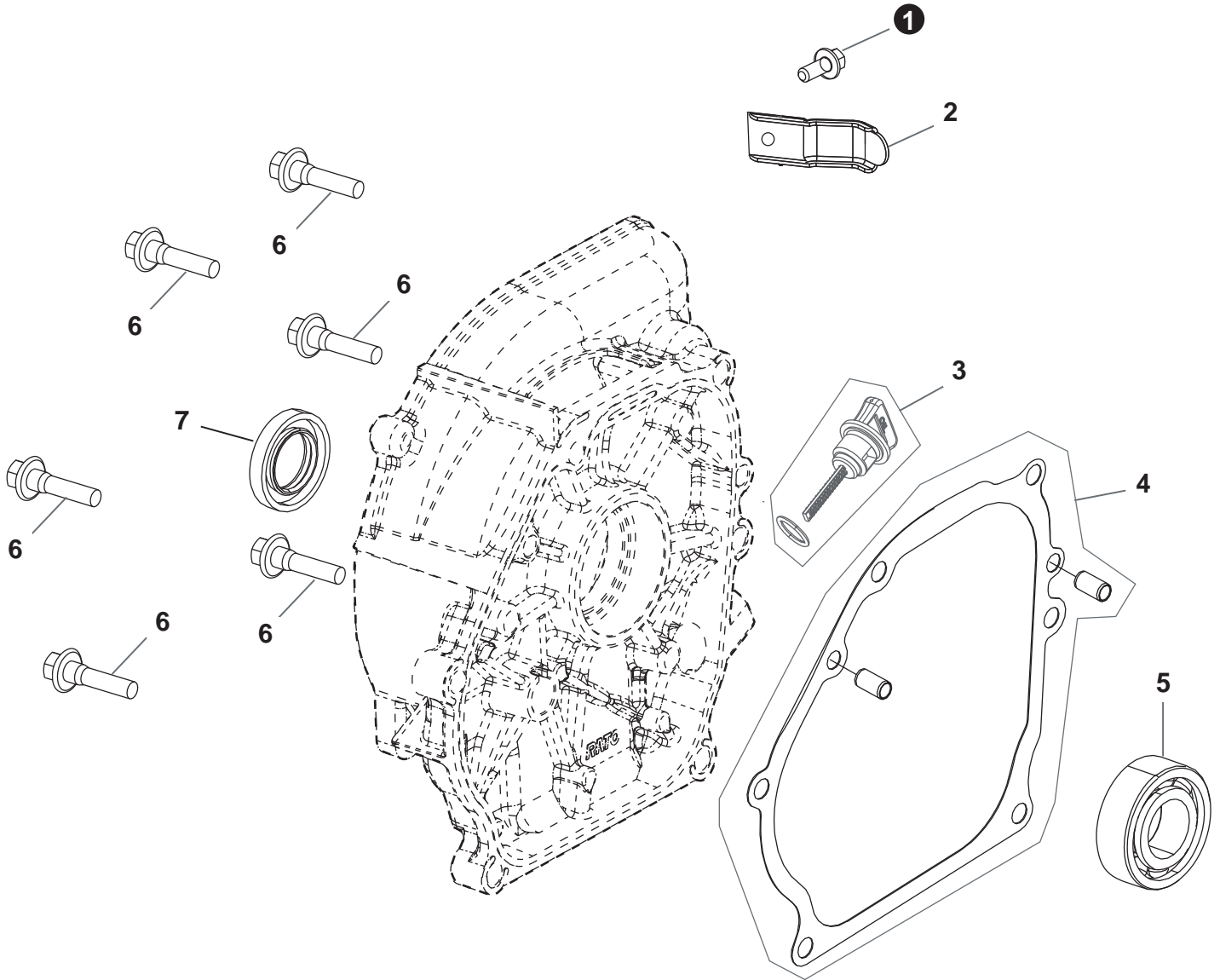

NO.	PART NUMBER	QTY.	DESCRIPTION	DESCRIPCIÓN
1	YH435000070	1	BOLT	TORNILLO
2	YH468000640	1	CLAMP	ABRAZADERA
3	YH470000130	1	DIPSTICK SUBASSEMBLY, OIL	CONJUNTO DE DIPSTICK, ACEITE
4	YH468000540	1	GASKET KIT, CRANKCASE	KIT DE JUNTAS, CÁRTER
5	YH453000150	1	BEARING, CRANKSHAFT	RODAMIENTO, CIGÜEÑAL
6	YH435000130	6	BOLT	TORNILLO
7	YH468000520	1	SEAL, OIL	ACEITE DE FOCA

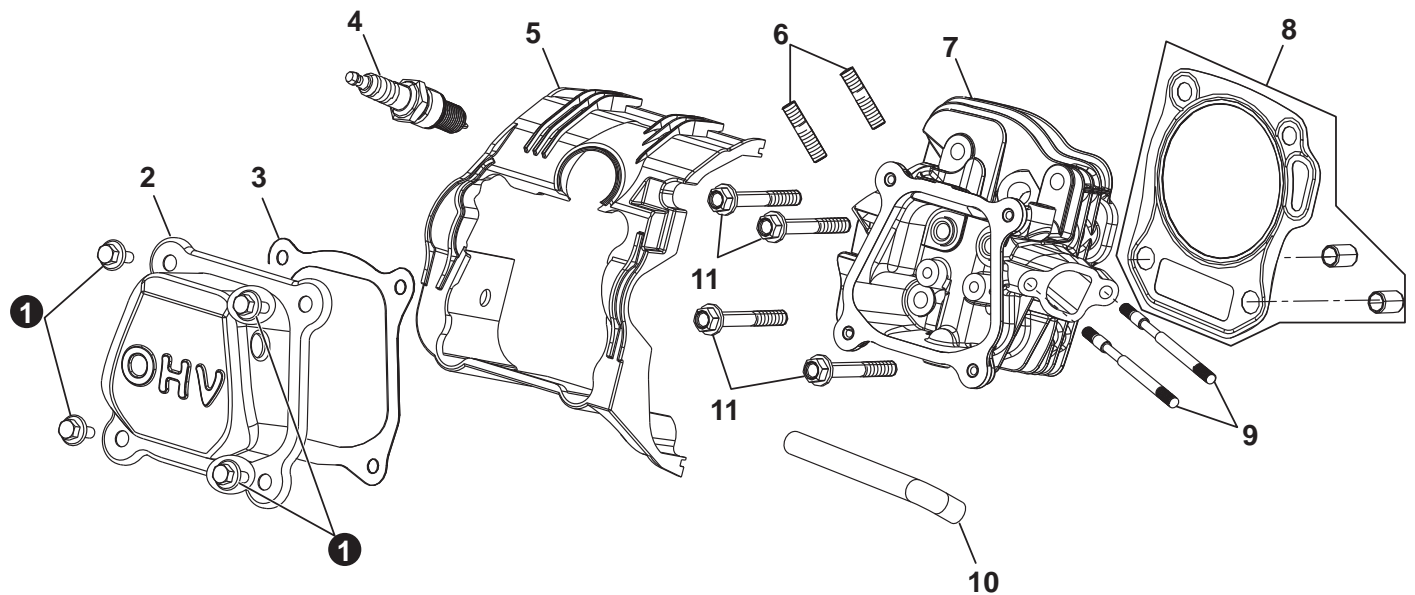

NO.	PART NUMBER	QTY.	DESCRIPTION	DESCRIPCIÓN
1	YH435000140	4	BOLT	TORNILLO
2	YH458000090	1	COVER, VALVE	CUBIERTA, VÁLVULA
3	YH468000310	1	GASKET, VALVE COVER	JUNTA, CUBIERTA DE VÁLVULA
4	YH461000290	1	SPARK PLUG	BUJÍA
5	YH479000770	1	SHROUD, CYLINDER BODY	CUBIERTA, CUERPO DEL CILINDRO
6	YH452000710	2	STUD, INTAKE	STUD, INGESTA
7	YH458000000	1	HEAD, CYLINDER	CABEZA, CILINDRO
8	YH468001670	1	GASKET KIT, CYLINDER HEAD	KIT DE JUNTAS, CULATA
9	YH452000080	2	BOLT	TORNILLO
10	YH467000210	1	TUBE, BREATHER	TUBO, RESPIRADOR
11	YH435000170	4	BOLT, CYLINDER HEAD	PERNO, CULATA

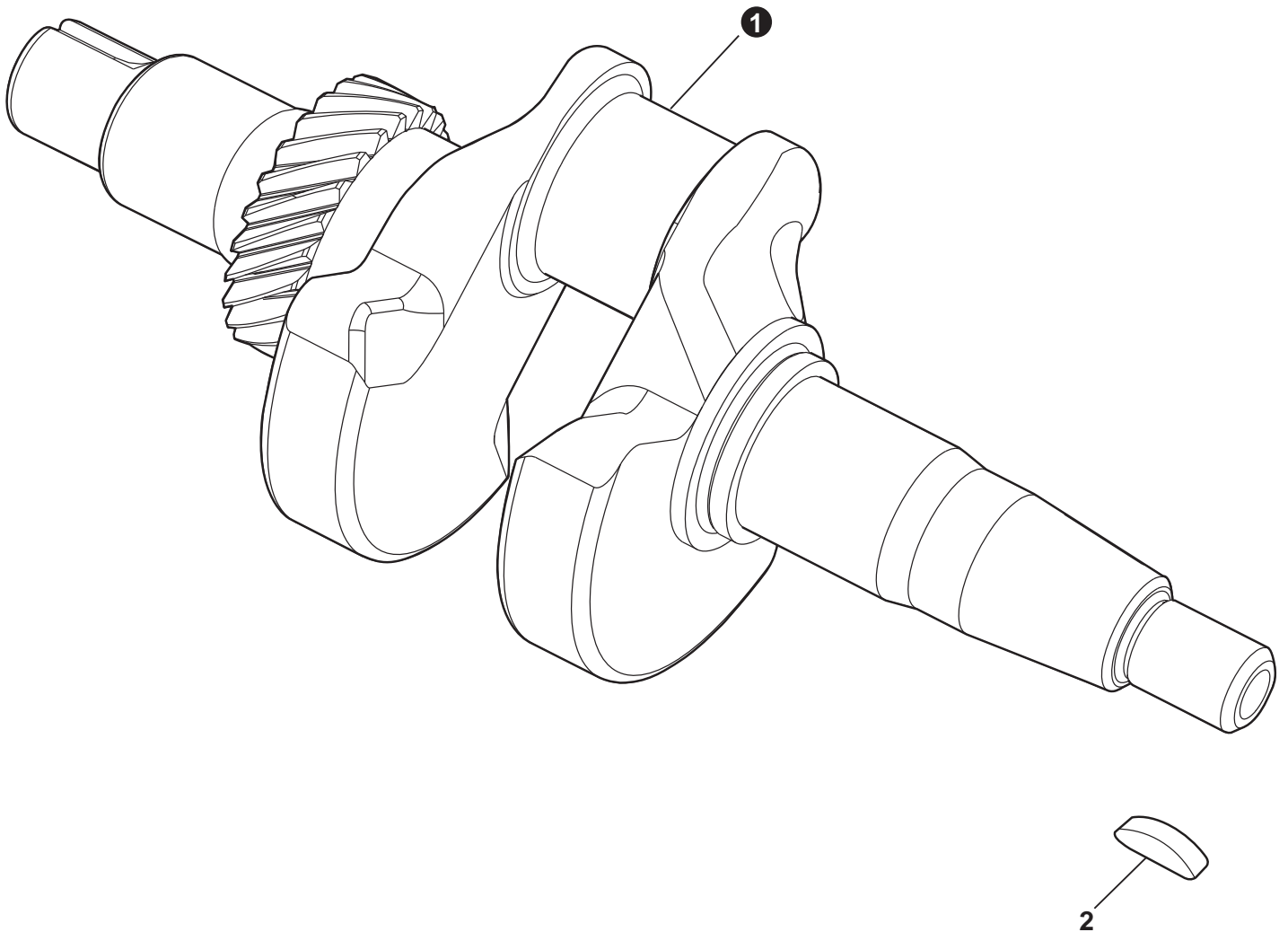

NO.	PART NUMBER	QTY.	DESCRIPTION	DESCRIPCIÓN
1	YH458000400	1	ASSY., CRANKSHAFT	CONJUNTO., CIGÜEÑAL
2	YH469000000	1	KEY, CRANKSHAFT	LLAVE, CIGÜEÑAL

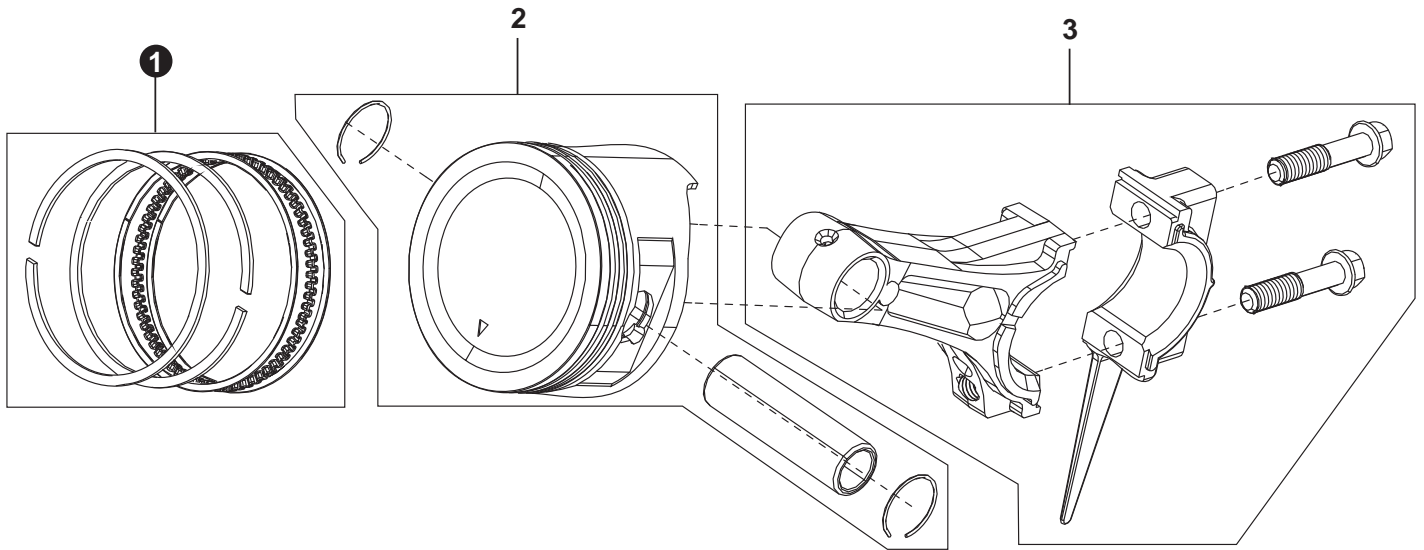

NO.	PART NUMBER	QTY.	DESCRIPTION	DESCRIPCIÓN
1	YH458000410	1	SET, PISTON RING	SET, ANILLO DE PISTON
2	YH458000430	1	KIT, PISTON	KIT, PISTON
3	YH458000420	1	ASSY., CONNECTING ROD	SET., VARILLA DE CONEXIÓN

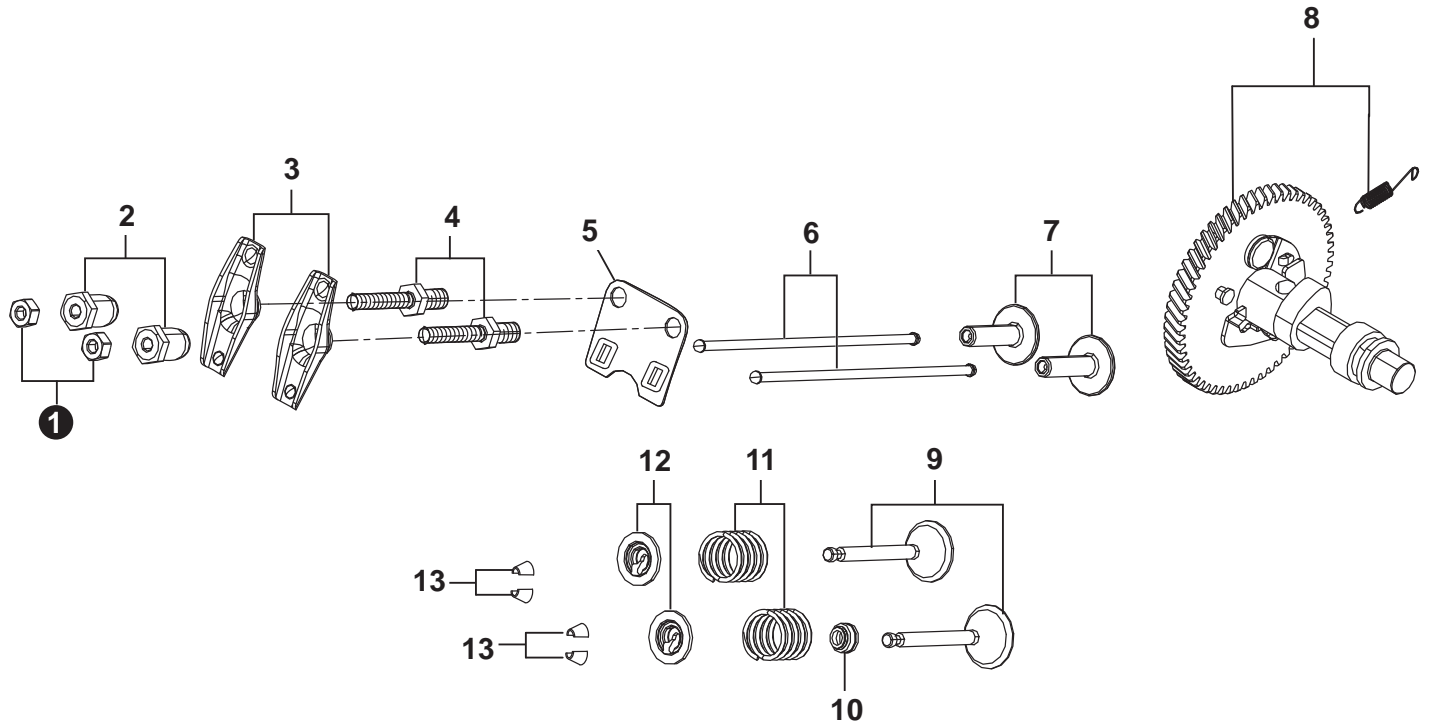

NO.	PART NUMBER	QTY.	DESCRIPTION	DESCRIPCIÓN
1	YH458000220	2	NUT, VALVE LOCK	TUERCA, BLOQUEO DE VÁLVULA
2	YH458000210	2	NUT, VALVE ADJUSTING	TUERCA, AJUSTE DE VÁLVULA
3	YH458000200	2	ARM, ROCKER	BRAZO, BALANCINES
4	YH458000190	2	BOLT, ROCKER SHAFT	PERNO, EJE DE BALANCINES
5	YH458000180	1	PLATE, LIFTER STOPPER	PLACA, TAPÓN DE ELECCIÓN
6	YH458000170	2	ROD, PUSH	BARRA DE EMPUJE
7	YH458000160	2	TAPPET, VALVE	TAPETA, VÁLVULA
8	YH458000350	1	ASSY., CAMSHAFT	CONJUNTO. ARBOL DE LEVAS
9	YH458000110	1	VALVES SET, INTAKE/EXHAUST	JUEGO DE VÁLVULAS, ADMISIÓN / ESCAPE
10	YH458000120	1	SEAL, GUIDE	SELLO, GUÍA
11	YH458000130	2	SPRING, VALVE	RESORTE, VÁLVULA
12	YH458000150	2	SEAT, VALVE SPRING	ASIENTO, RESORTE DE VÁLVULA
13	YH458000140	4	CLAMP, VALVE LOCK	ABRAZADERA, BLOQUEO DE VÁLVULA

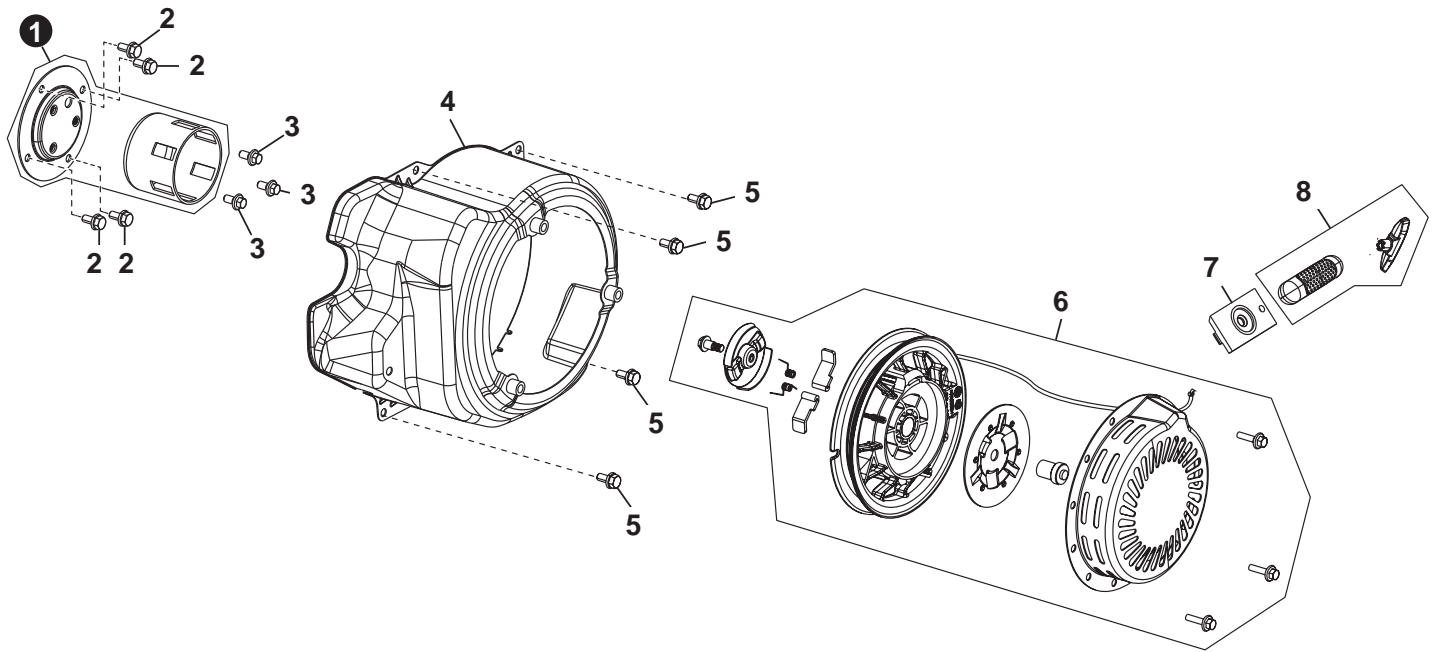

NO.	PART NUMBER	QTY.	DESCRIPTION	DESCRIPCIÓN
1	YH463000240	1	ASSY., STARTER CUP	SET., COPA DE ARRANQUE
2	YH435000070	4	BOLT	TORNILLO
3	YH435000110	3	BOLT	TORNILLO
4	YH479001650	1	SHROUD, FAN	CUBIERTA, VENTILADOR
5	YH435000140	4	BOLT	TORNILLO
6	YH463000230	1	ASSY., STARTER RECOIL	CONJUNTO., ARRANQUE RETROCESO
7	YH466000020	1	GUIDE, STARTING ROPE	GUÍA, CUERDA DE INICIO
8	YH466000420	1	HANDLE KIT, STARTER ROPE	KIT DE MANGO, CUERDA DE ARRANQUE

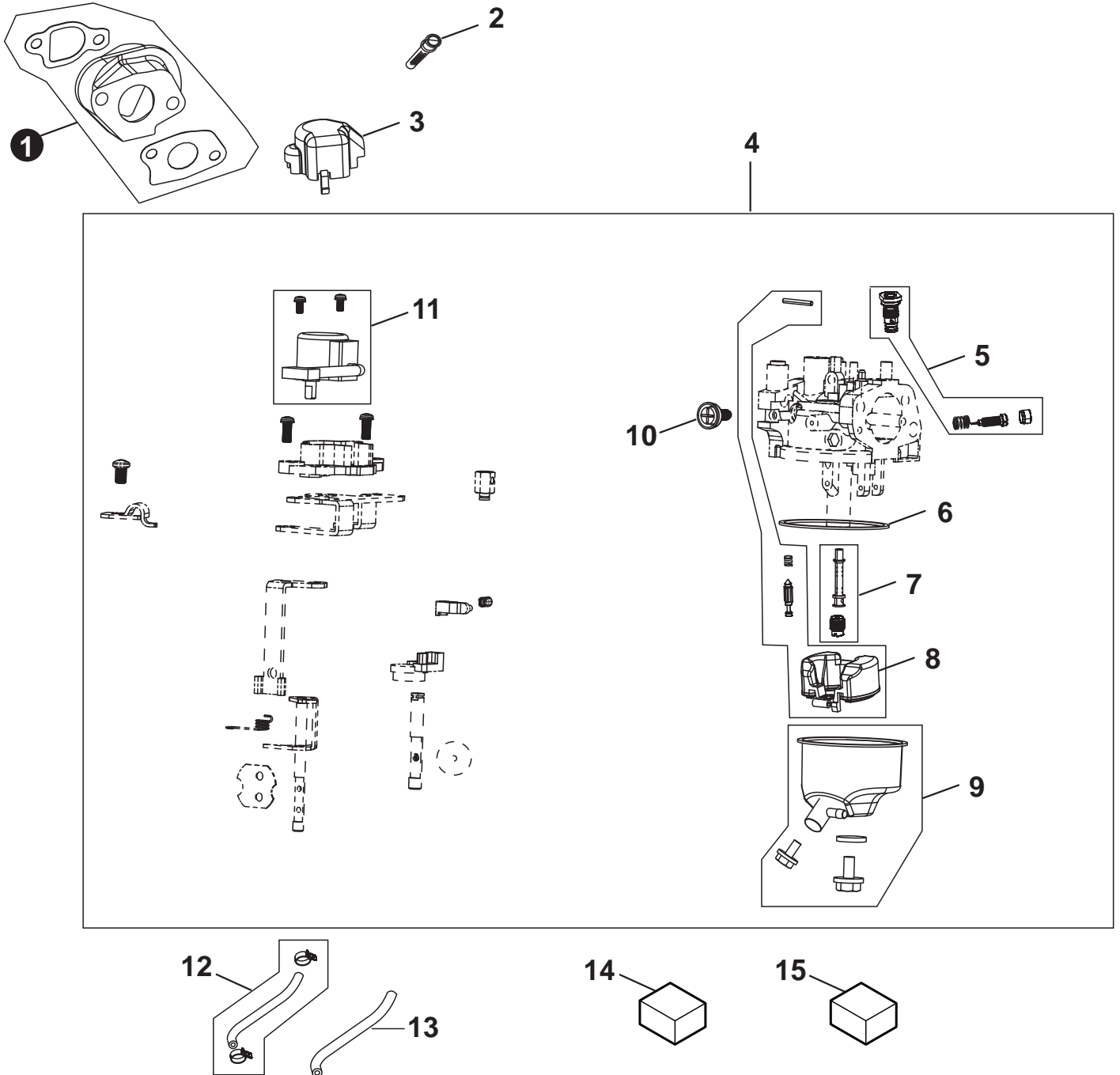

NO.	PART NUMBER	QTY.	DESCRIPTION	DESCRIPCIÓN
1	YH468000780	1	SET, CARBURETOR GASKET	JUEGO, JUNTA DE CARBURADOR
2	YH465000230	1	STRAINER, FUEL	FILTRO, COMBUSTIBLE
3	YH468001150	1	CAP, STEPPER MOTOR	TAPA, MOTOR PASO A PASO
4	YH459000640	1	ASSY., CARBURETOR	CONJUNTO., CARBURADOR
5	YH459000610	1	+KIT, IDLE SPEED JET	+KIT, JET DE VELOCIDAD INACTIVA
6	YH459000490	1	+GASKET, FLOAT BOWL	+JUNTA, BOLO FLOTANTE
7	YH459000320	1	+KIT, MAIN JET	+KIT, CHORRO PRINCIPAL
8	YH459000130	1	+KIT, FLOAT/NEEDLE	+KIT, FLOTADOR / AGUJA
9	YH459000110	1	+KIT, CARBURETOR BOWL	+KIT, TAZA DE CARBURADOR
10	YH459000620	1	+SCREW, IDLE SPEED ADJUSTING	+TORNILLO, AJUSTE DE VELOCIDAD INACTIVA
11	YH459000630	1	+MOTOR, STEPPER	+MOTOR, PASO A PASO
12	YH467000500	1	KIT, FUEL HOSE	KIT, MANGUERA DE COMBUSTIBLE
13	YH467000570	1	HOSE, FUEL	MANGUERA, COMBUSTIBLE
14	YH459000660	1	KIT, HIGH ALTITUDE 3K-6K	KIT ALTA ALTITUD 3K-6K
15	YH459000670	1	KIT, HIGH ALTITUDE 6K-8K	KIT ALTA ALTITUD 6K-8K

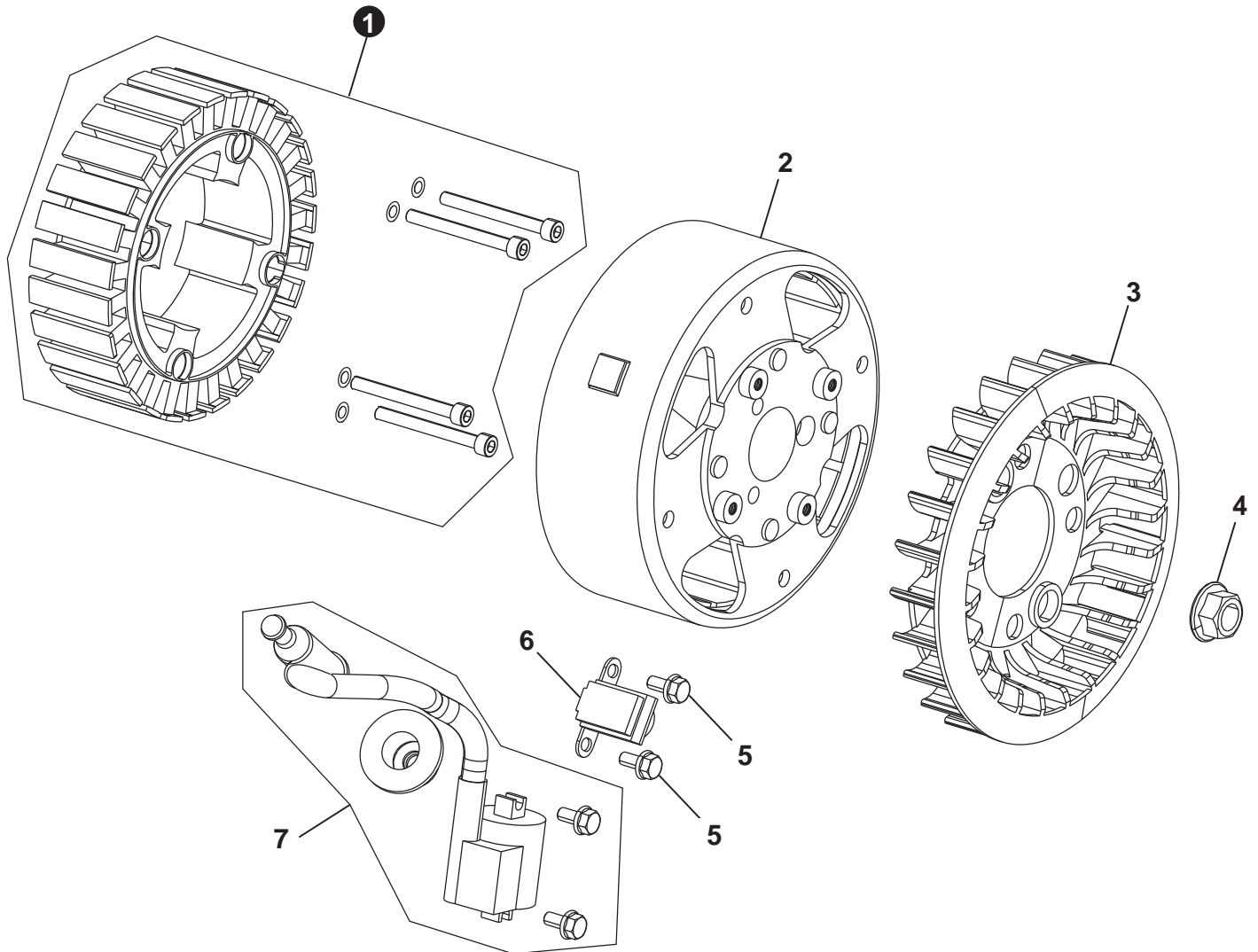

NO.	PART NUMBER	QTY.	DESCRIPTION	DESCRIPCIÓN
1	YH315000090	1	STATOR	ESTATOR
2	YH479001660	1	CASE, MAGNETO ROTOR	ESTUCHE, ROTOR MAGNETO
3	YH315000080	1	IMPELLER	IMPULSO
4	YH450000060	1	NUT, FLYWHEEL	TUERCA, VOLANTE
5	YH435000300	2	BOLT	TORNILLO
6	YH461000120	1	TRIGGER, IGNITION	GATILLO, ENCENDIDO
7	YH461000300	1	COIL, IGNITION	BOBINA, ENCENDIDO

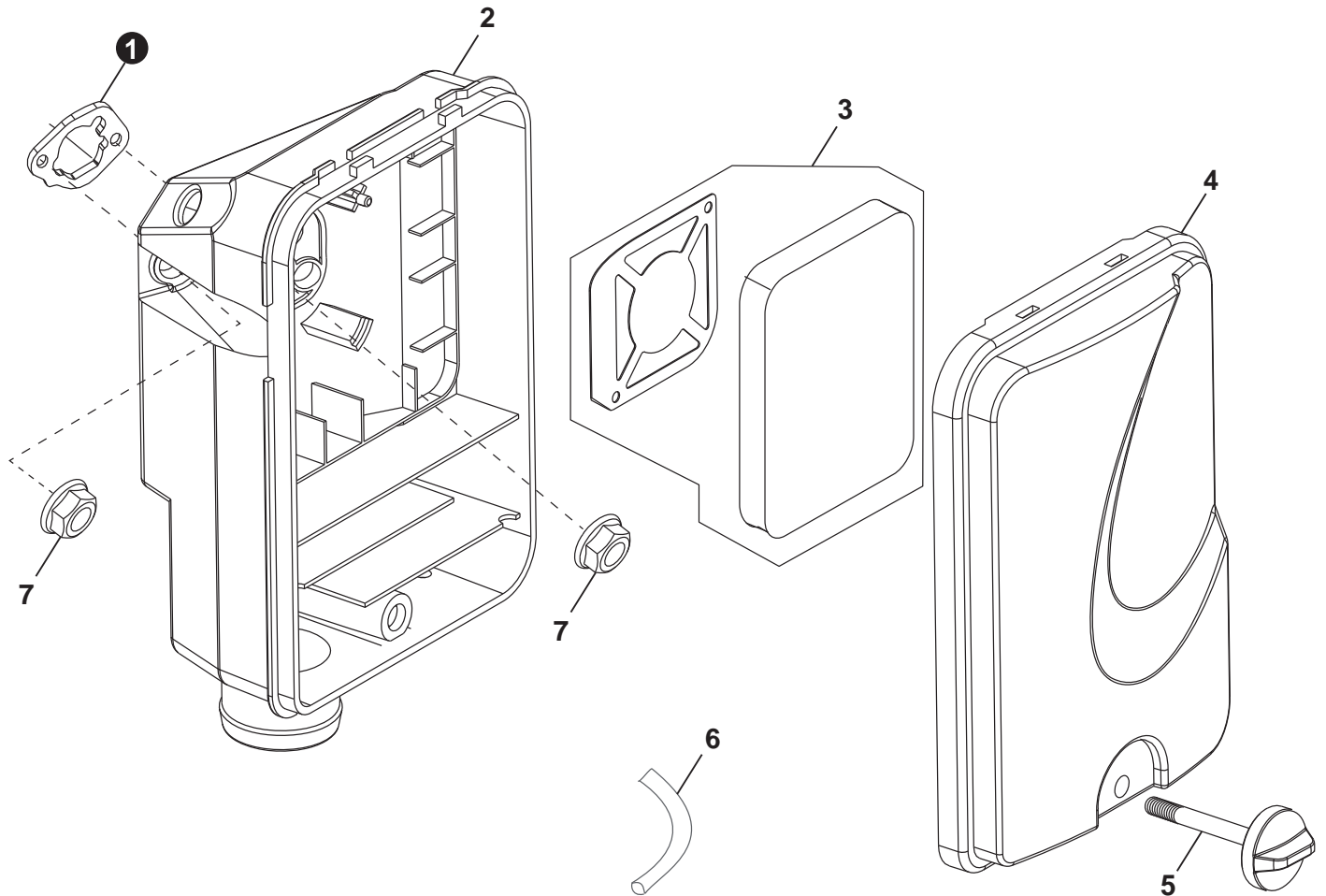

NO.	PART NUMBER	QTY.	DESCRIPTION	DESCRIPCIÓN
1	YH468001400	1	GASKET, AIR CLEANER	JUNTA, FILTRO DE AIRE
2	YH479001970	1	HOUSING, AIR CLEANER	VIVIENDA, FILTRO DE AIRE
3	YH465000240	1	ELEMENT, AIR CLEANER	ELEMENTO, FILTRO DE AIRE
4	YH479001980	1	COVER, AIR CLEANER	CUBIERTA, FILTRO DE AIRE
5	YH452000720	1	NUT, WING	TUERCA MARIPOSA
6	YH467000580	1	TUBE, OIL DRAIN	TUBO, CAMBIO DE ACEITE
7	YH450000070	2	NUT	NUEZ

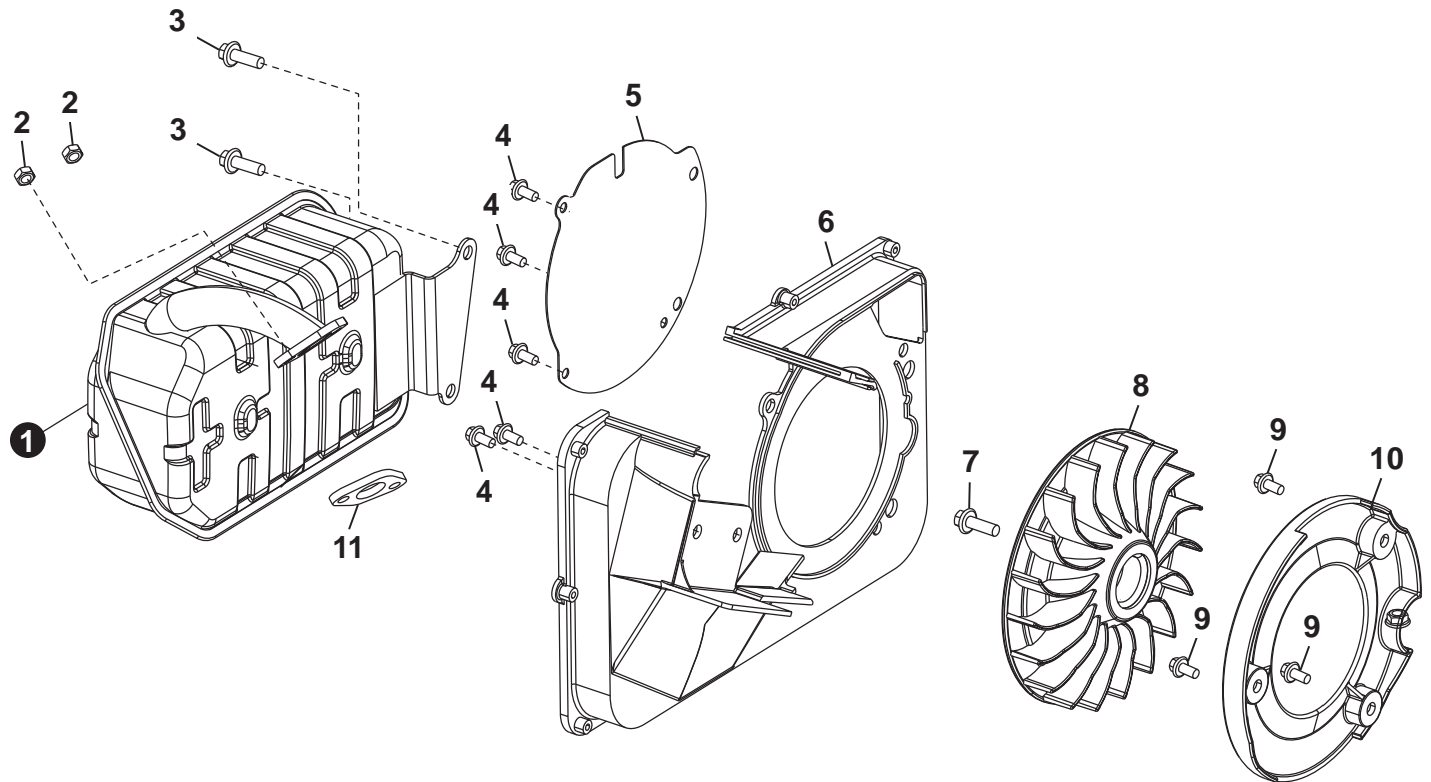

NO.	PART NUMBER	QTY.	DESCRIPTION	DESCRIPCIÓN
1	YH460000110	1	ASSY., MUFFLER	CONJUNTO, SILENCIADOR
2	YH450000220	2	NUT	NUEZ
3	YH435000360	2	BOLT	TORNILLO
4	YH435000190	5	BOLT	TORNILLO
5	YH435000120	1	PLATE, SEPARATOR	PLACA, SEPARADOR
6	YH479002000	1	PLATE, MUFFLER INSULATOR	PLACA, AISLADOR DE SILENCIADOR
7	YH435000050	1	BOLT	TORNILLO
8	YH472000120	1	FAN	VENTILADOR
9	YH435000140	3	BOLT	TORNILLO
10	YH479001990	1	SHROUD	SUDARIO
11	YH468001520	1	GASKET, EXHAUST OUTLET	JUNTA, SALIDA DE ESCAPE

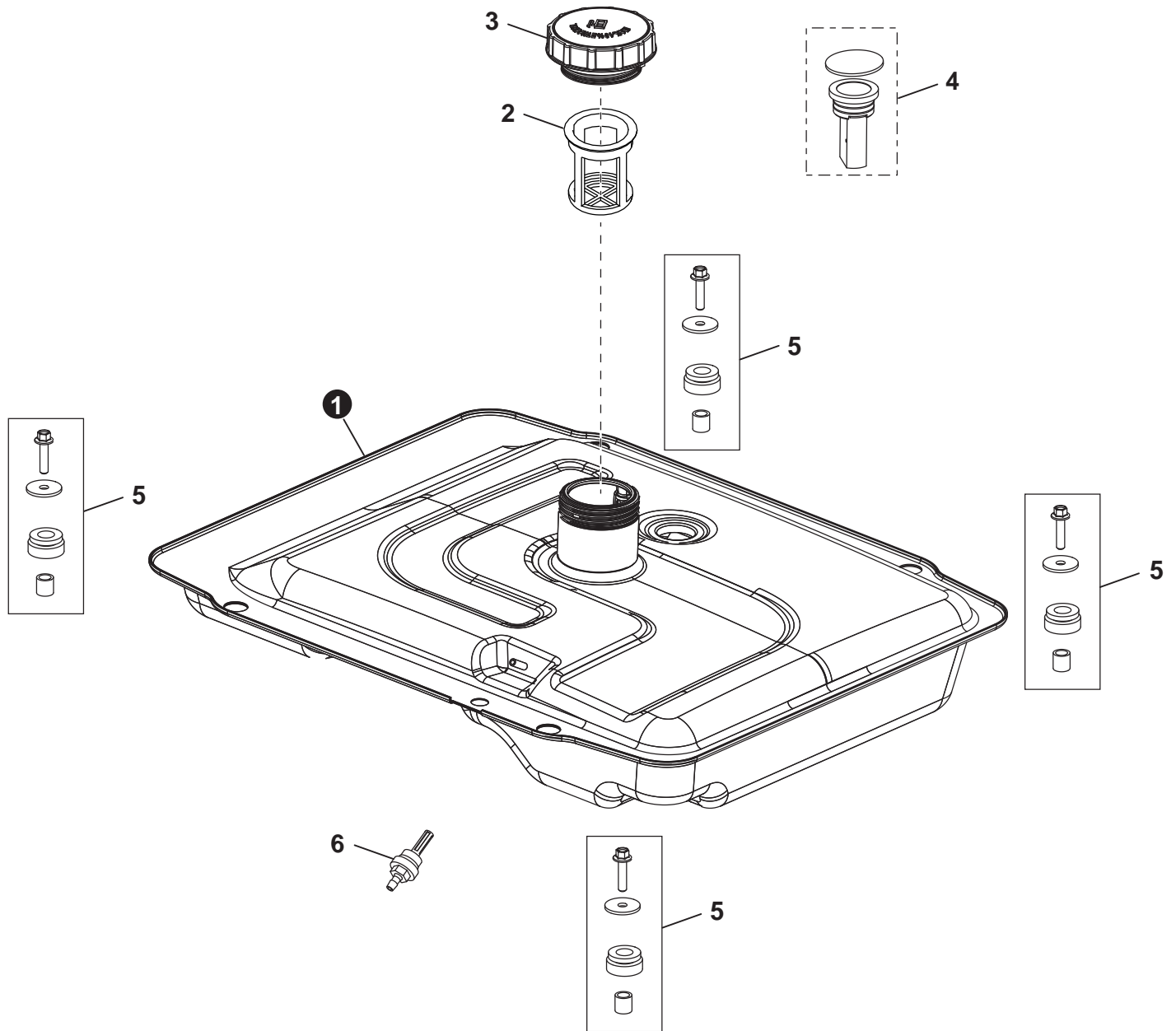

NO.	PART NUMBER	QTY.	DESCRIPTION	DESCRIPCIÓN
1	YH455000030	1	ASSY., FUEL TANK	CONJUNTO., TANQUE DE COMBUSTIBLE
2	YH465000250	1	STRAINER, FUEL	FILTRO, COMBUSTIBLE
3	YH468001540	1	CAP, FUEL	CAP, COMBUSTIBLE
4	YH470000890	1	ASSY., FUEL LEVEL	CONJUNTO., NIVEL DE COMBUSTIBLE
5	YH468001530	1	KIT, TANK MOUNT	KIT, MONTAJE EN TANQUE
6	YH467000590	1	OUTLET, FUEL TANK	SALIDA, TANQUE DE COMBUSTIBLE

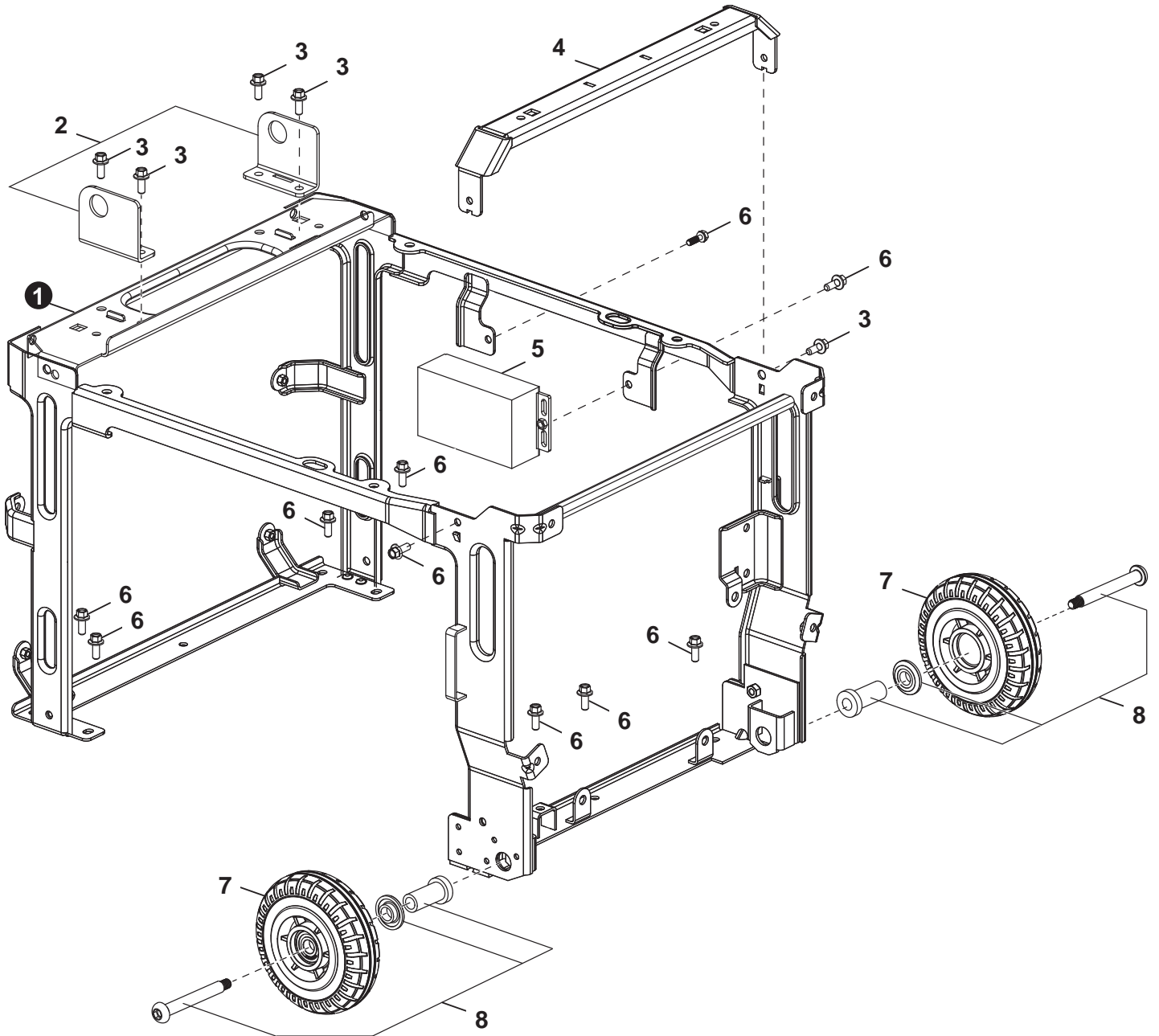



NO.	PART NUMBER	QTY.	DESCRIPTION	DESCRIPCIÓN
1	YH479002010	1	ASSY., FRAME	CONJUNTO., MARCO
2	YH479002020	1	KIT, HANDLE MOUNT	KIT, MONTAJE DE MANGO
3	YH435000140	5	BOLT	TORNILLO
4	YH479002030	1	SUPPORT	APOYO
5	YH311000010	1	CONTROLLER	CONTROLADOR
6	YH435000190	9	BOLT	TORNILLO
7	YH478000160	2	WHEEL, FRONT	RUEDA DELANTERA
8	YH478000150	2	AXLE, WHEEL	EJE RUEDA

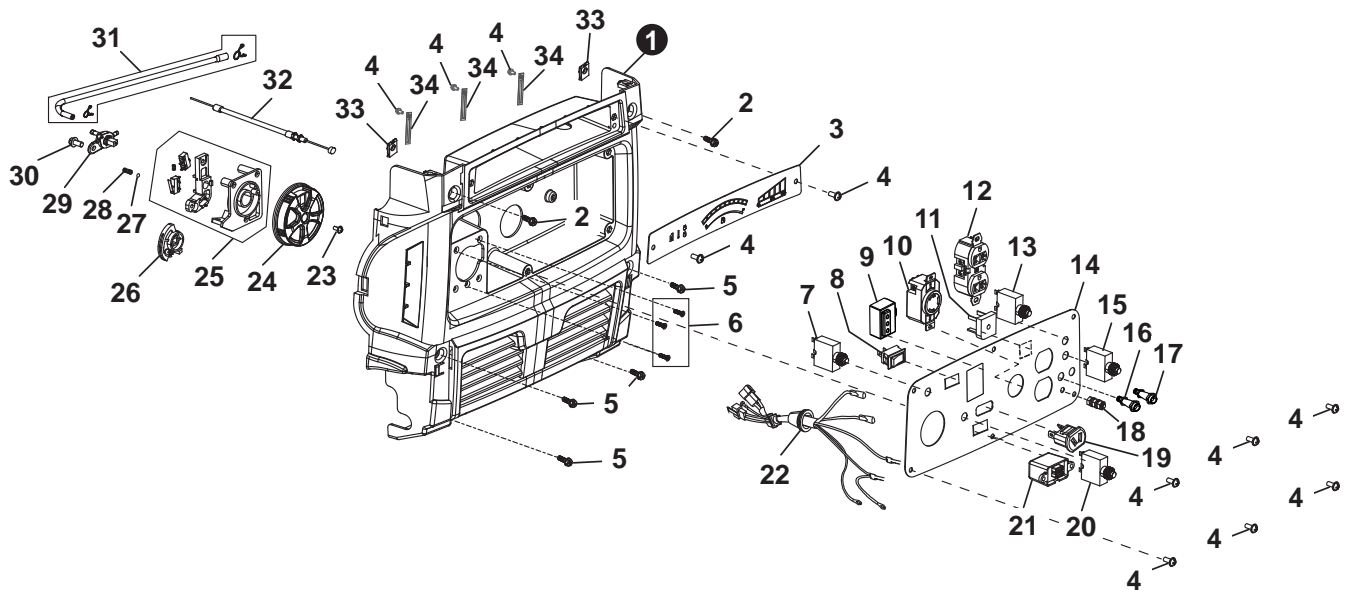



NO.	PART NUMBER	QTY.	DESCRIPTION	DESCRIPCIÓN
1	YH479002050	1	SEAT, PANEL	ASIENTO, PANEL
2	YH435000080	2	BOLT	TORNILLO
3	YH479002060	1	PANEL, METER	PANEL, MEDIDOR
4	YH415000360	11	SCREW	TORNILLO
5	YH435000060	4	BOLT	TORNILLO
6	YH415000150	3	SCREW, CROSS GROOVE PAN	TORNILLO, CROSS GROOVE PAN
7	YH321000020	1	SWITCH, RESET	INTERRUPTOR, RESET
8	YH321000010	1	SWITCH, AUTO THROTTLE	INTERRUPTOR, ACELERADOR AUTOMÁTICO
9	YH321000210	1	SWITCH,STARTER	INTERRUPTOR, ARRANQUE
10	YH304000140	1	SOCKET, POWER SUPPLY	ENCHUFE, FUENTE DE ALIMENTACIÓN
11	YH308000000	1	BRIDGE, RECTIFICATION	PUENTE, RECTIFICACIÓN
12	YH304000020	1	SOCKET, POWER SUPPLY	ENCHUFE, FUENTE DE ALIMENTACIÓN
13	YH318000070	1	BREAKER, CIRCUIT	INTERRUPTOR, CIRCUITO
14	YH479002040	1	PANEL, CONTROL	PANEL DE CONTROL
15	YH318000080	1	BREAKER, CIRCUIT	INTERRUPTOR, CIRCUITO
16	YH304000000	1	SOCKET, PARALLEL (RED)	ENCHUFE, PARALELO (ROJO)
17	YH304000010	1	SOCKET, PARALLEL (BLACK)	SOCKET,PARALELO (NEGRO)
18	YH304000050	1	TERMINAL, GROUND BOLT	TERMINAL, PERNO DE TIERRA
19	YH304000030	1	SOCKET, D.C. CHARGE	ENCHUFE, CARGA DC
20	YH318000090	1	BREAKER, CIRCUIT	INDICADOR, LED
21	YH304000040	1	SOCKET, USB PORT	SOCKET, PUERTO USB
22	YH601000180	1	HARNESS, WIRING	ARNÉS, CABLEADO
23	YH415000160	1	SCREW	TORNILLO
24	YH470000920	1	KNOB,START/RUN CONTROL	PERILLA, CONTROL DE ARRANQUE / MARCHA
25	YH321000200	1	SWITCH ASSEMBLY	CONJUNTO INTERRUPTOR
26	YH479000170	1	COVER, BOARD	CUBIERTA, TABLERO
27	YH453000010	1	BALL, STEEL	BOLA DE ACERO
28	YH476000040	1	SPRING, STOPPER ADJUSTING	RESORTE, AJUSTE DE TAPONES
29	YH470000110	1	VALVE, FUEL SHUT OFF	VÁLVULA, CIERRE DE COMBUSTIBLE
30	YH435000140	1	BOLT	TORNILLO
31	YH467000600	1	HOSE, FUEL	MANGUERA, COMBUSTIBLE
32	YH601000190	1	CABLE, CHOKE	CABLE, CHOKE
33	YH450000240	2	NUT	NUEZ
34	YH452000030	3	CLIP	FRAGMENTO DE UNA PELÍCULA

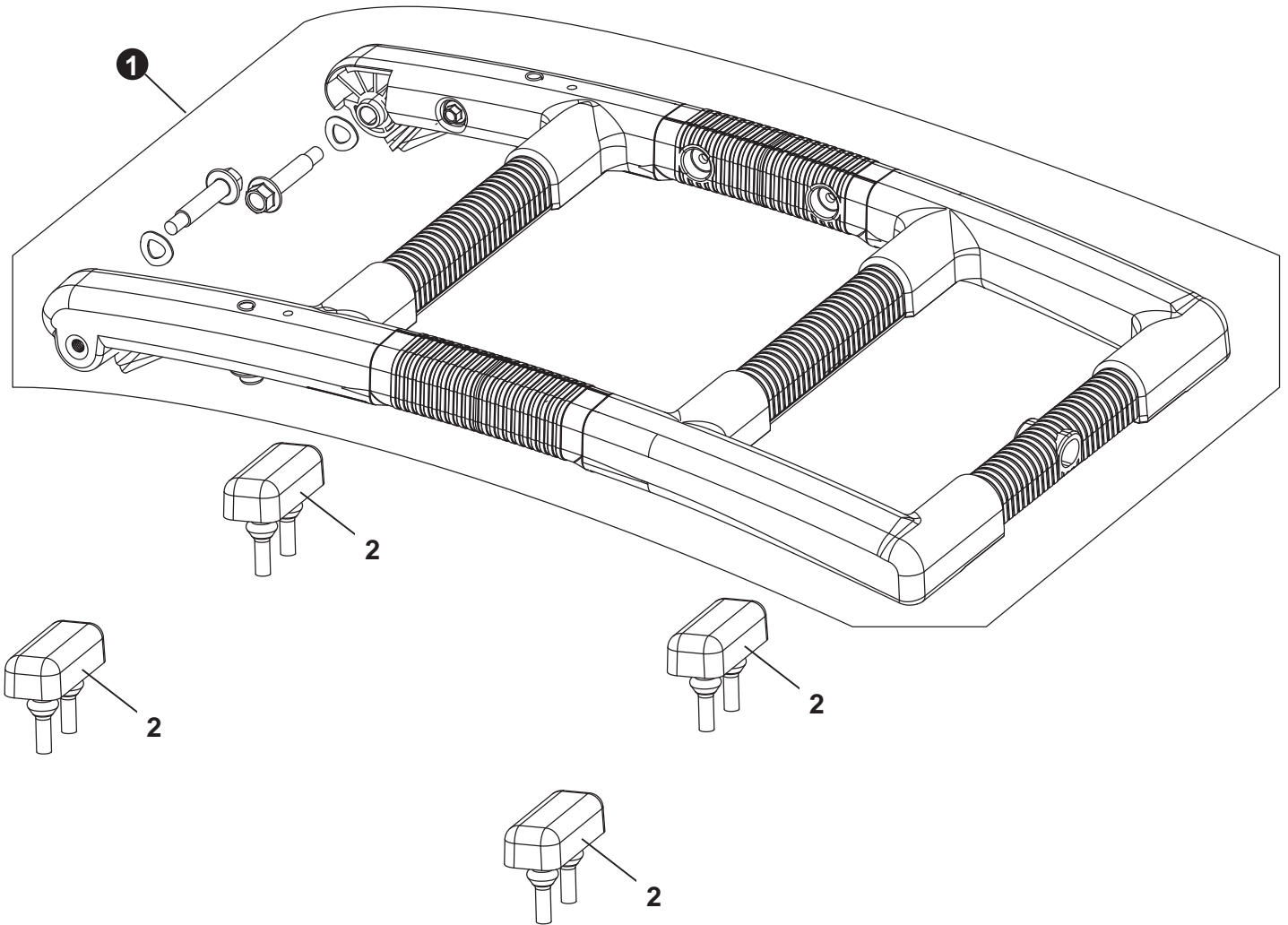

NO.	PART NUMBER	QTY.	DESCRIPTION	DESCRIPCIÓN
1	YH466000450	1	ASSEMBLY, HANDLE	MONTAJE, MANGO
2	YH468001550	4	ISOLATOR	AISLADOR

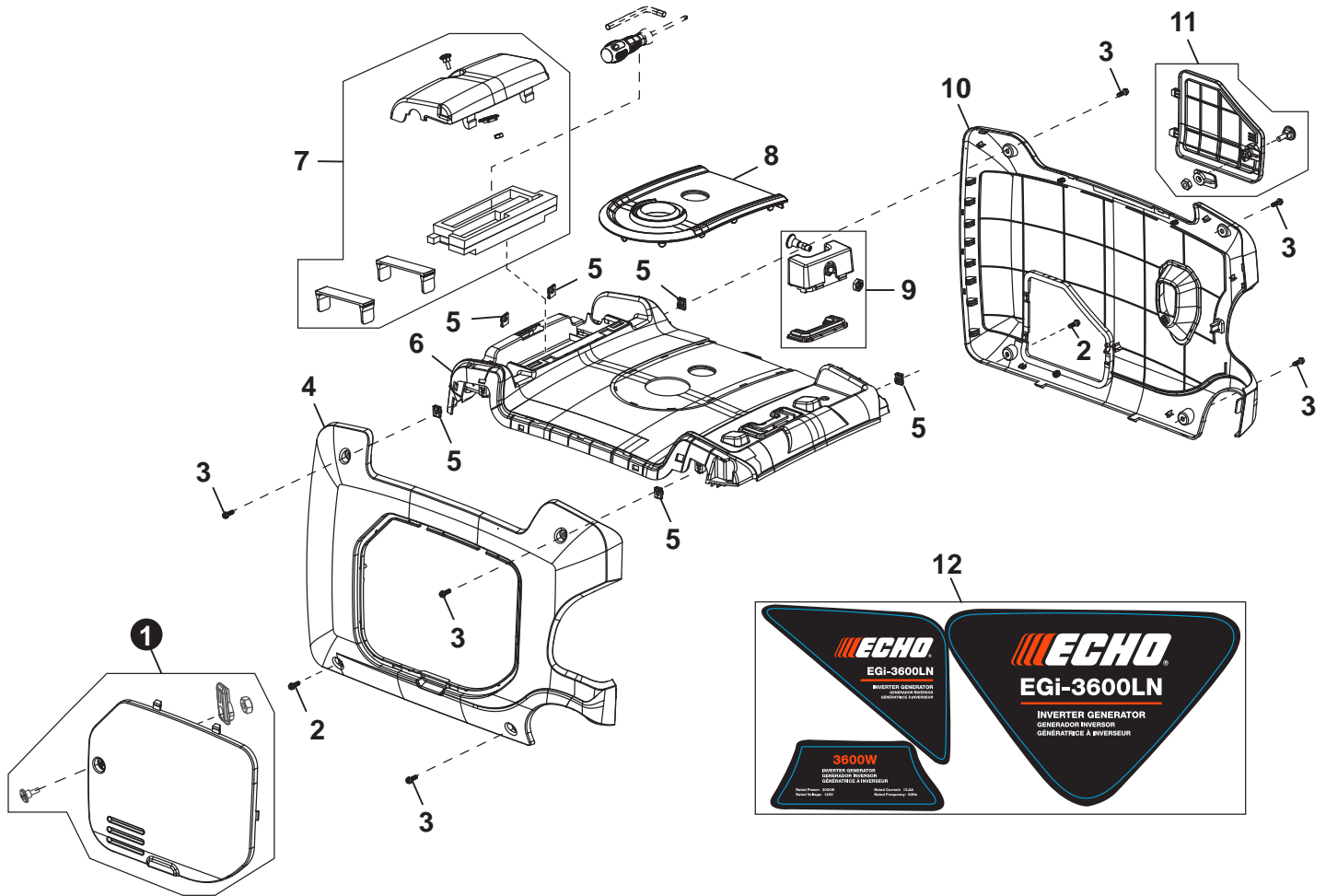

NO.	PART NUMBER	QTY.	DESCRIPTION	DESCRIPCIÓN
1	YH479002080	1	ASSY., LEFT MAINTENANCE DOOR	CONJUNTO., IZQUIERDA PUERTA DE MANTENIMIENTO
2	YH435000060	2	BOLT	TORNILLO
3	YH435000080	6	BOLT	TORNILLO
4	YH479002070	1	PANEL, LEFT HOUSING	PANEL, IZQUIERDA
5	YH450000240	6	NUT	NUEZ
6	YH479002110	1	COVER, UPPER	CUBIERTA SUPERIOR
7	YH479002130	1	ASSY., COVER	CONJUNTO., CUBIERTA
8	YH479002120	1	COVER, SPILL	CUBIERTA, DERRAME
9	YH479002140	1	ASSY., COVER	CONJUNTO., CUBIERTA
10	YH479002090	1	PANEL, RIGHT HOUSING	PANEL, VIVIENDA DERECHA
11	YH479002100	1	ASSY., RIGHT MAINTENANCE DOOR	CONJUNTO., PUERTA DE MANTENIMIENTO DERECHA
12	YH653000800	1	SET, EGi-3600LN LABEL	SET, ETIQUETA EGi-3600LN

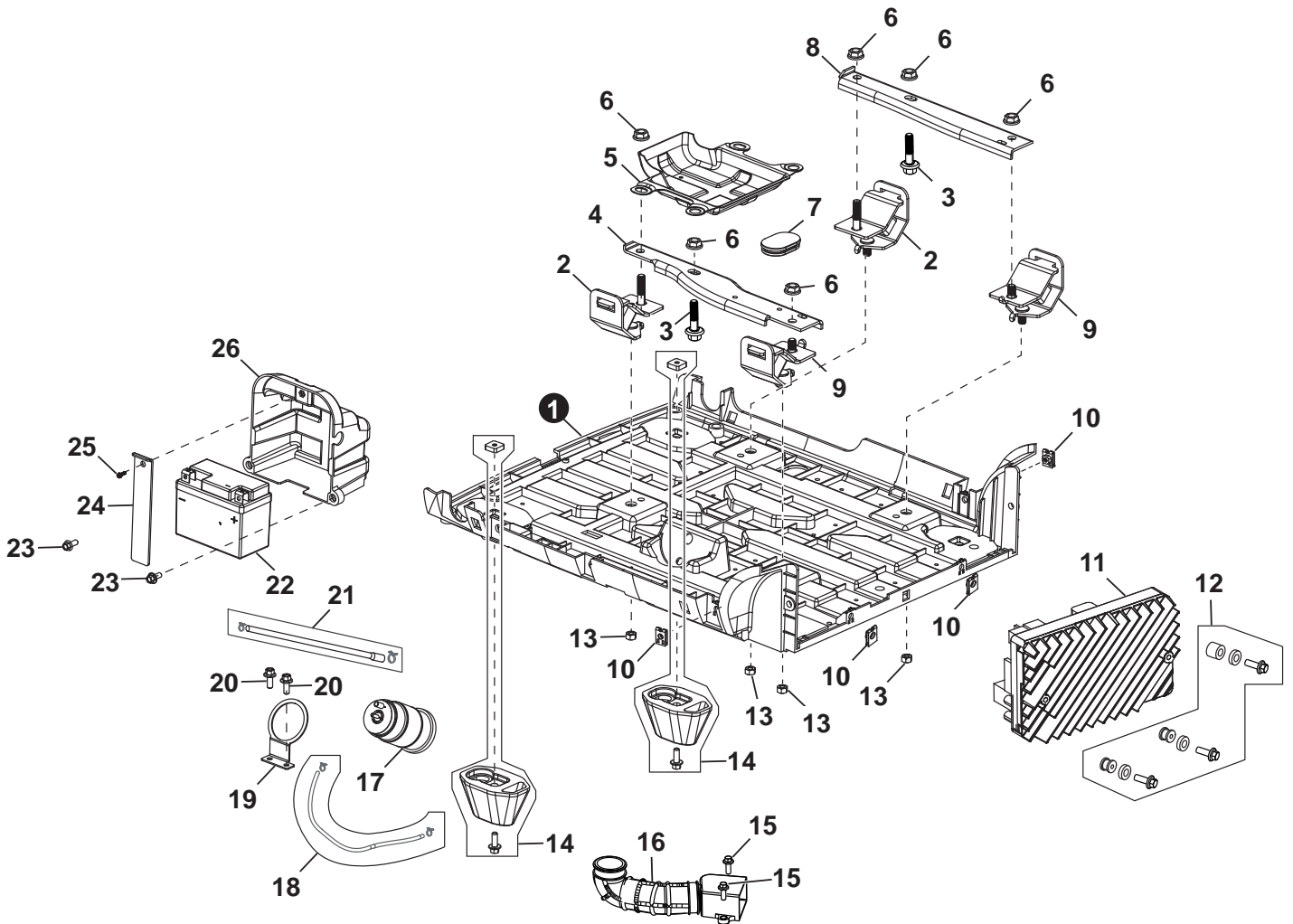



NO.	PART NUMBER	QTY.	DESCRIPTION	DESCRIPCIÓN
1	YH479002150	1	HOUSING, BASE	VIVIENDA, BASE
2	YH468001580	2	MOUNT, RIGHT ENGINE	MONTAJE, MOTOR DERECHO
3	YH435000270	2	BOLT	TORNILLO
4	YH466000460	1	BRACKET, LEFT SUPPORT	SOPORTE, IZQUIERDO
5	YH468001610	1	DEFLECTOR, CRANKCASE AIR	DEFLECTOR, AIRE DEL CIGÜEÑAL
6	YH450000370	6	NUT	NUEZ
7	YH468001570	1	PLUG, END	ENCHUFE, FIN
8	YH466000470	1	BRACKET,RIGHT SUPPORT	SOPORTE, DERECHO
9	YH468001590	2	MOUNT, LEFT ENGINE	MONTAJE, MOTOR IZQUIERDO
10	YH450000240	2	NUT	NUEZ
11	YH315000100	1	INVERTER	INVERSOR
12	YH468001600	1	KIT, INVERTER MOUNT	KIT, MONTAJE INVERSOR
13	YH450000370	4	NUT	NUEZ
14	YH468001560	2	FEET, FRAME	PIES, MARCO
15	YH435000190	2	BOLT	TORNILLO
16	YH467000610	1	DUCT, AIR CLEANER INTAKE	CONDUCTO, ADMISIÓN DE FILTRO DE AIRE
17	YH481000050	1	CANNISTER, VAPOR	CANNISTER, VAPOR
18	YH467000620	1	HOSE, AIR CLEANER	MANGUERA, FILTRO DE AIRE
19	YH468001620	1	BRACKET, CANNISTER	SOPORTE, CANNISTER
20	YH435000140	2	BOLT	TORNILLO
21	YH467000630	1	HOSE, FUEL VAPOR	MANGUERA, VAPOR DE COMBUSTIBLE
22	YH300000010	1	BATTERY	BATERÍA
23	YH435000190	2	BOLT	TORNILLO
24	YH452000730	1	CLAMP, BATTERY	ABRAZADERA, BATERÍA
25	YH435000140	1	BOLT	TORNILLO
26	YH479002160	1	CASE, BATTERY	CASO, BATERIA

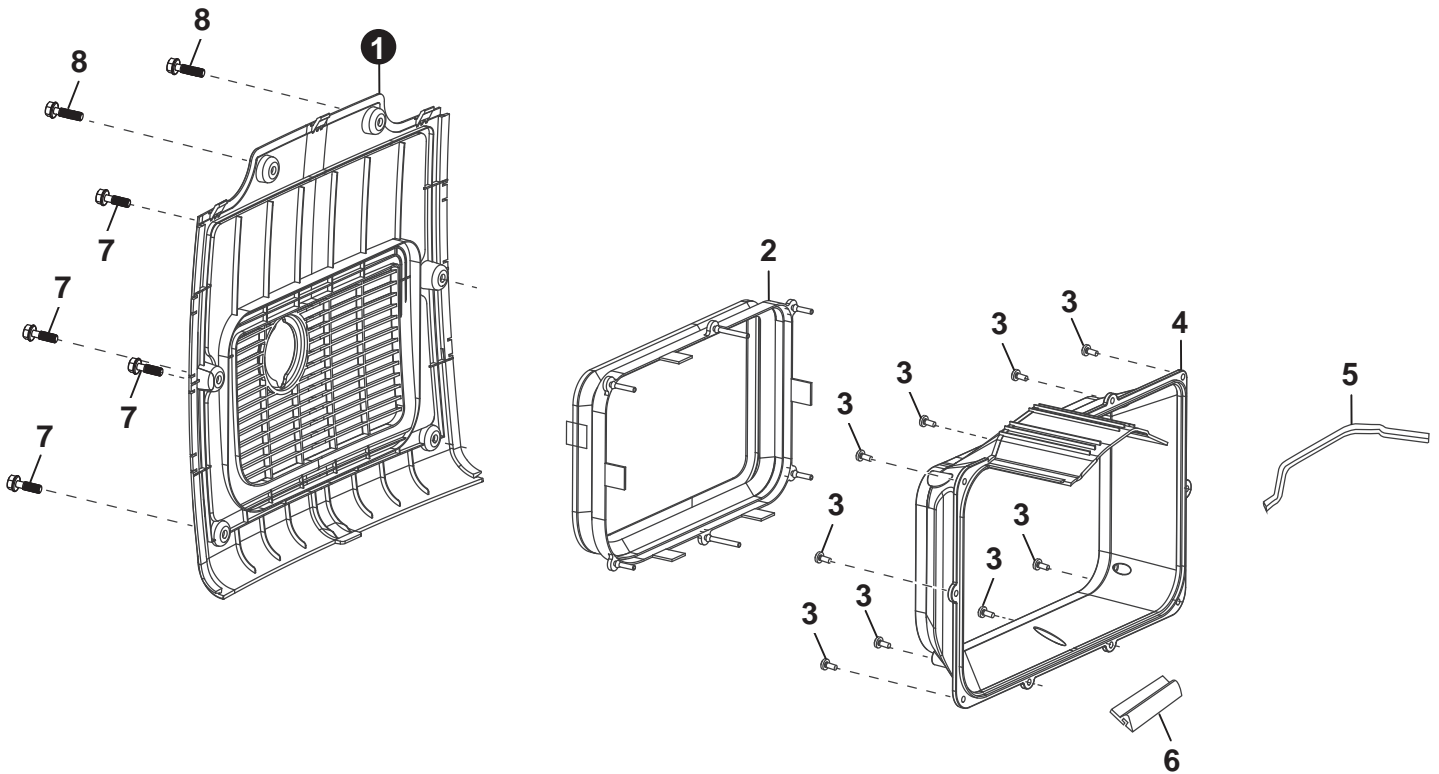

NO.	PART NUMBER	QTY.	DESCRIPTION	DESCRIPCIÓN
1	YH479002190	1	COVER, MUFFLER SIDE	CUBIERTA, LADO DEL SILENCIADOR
2	YH479002180	1	COVER, MUFFLER INNER	CUBIERTA, SILENCIADOR INTERIOR
3	YH415000570	9	SCREW	TORNILLO
4	YH479002170	1	COVER, MUFFLER OUTER	CUBIERTA, SILENCIADOR EXTERIOR
5	YH468001630	1	STRIP, SHROUD SEAL	TIRA, SELLO DE LA CUBIERTA
6	YH468001640	1	STRIP, SHROUD SEAL	TIRA, SELLO DE LA CUBIERTA
7	YH435000060	4	BOLT	TORNILLO
8	YH435000080	2	BOLT	TORNILLO